

# **EMC for test engineers**

by

## **Laplace Instruments Ltd**



**An introduction to the world of EMC compliance testing  
for engineers new to the topic.**

Index:

Introduction	Page 3
The EU Directive	Page 3
The EMC Standards.	Page 3
Compliance strategies	Page 4
Pre-Compliance vs Compliance	Page 5
Background Basics	Page 6
The Test Requirements: Emissions Harmonics & Flicker Immunity	Page 7
Emissions testing procedures: Conducted Radiated	Page 12
Using the EMC Analyser	Page 21
Annexes	Page 22

**Annexes**

1.	Why not use NFPs (Near Field Probes)	Creation of radiated EM waves. Wavelength Near and far field Current & voltage sources Magnetic & electric fields	Page 22
2.	Pre-selectors	Conducted emissions testing Types of interference signal Analyser characteristics Compression Attenuator settings	Page 26
3.	EN55022	Upper frequency limit	Page 31
4.	Harmonics and Flicker	Purpose of the requirement Harmonic classes Flicker assesment	Page 32
5.	LISN installation	Grounding Resonances Cables	Page 33
6.	Detectors	Types of detectors When to use Time constants Impulsive vs steady signals Effect of repetition rate	Page 35
7.	Radiated emissions for luminaires and diagram.		Page 39
8.	Background cancellation	Broadband vs narrowband ERS and CNE sources Background stability Averaging technique	Page 41
9.	Use of the reference source	Test sites Reflections Ground plane Antenna height Signal cancellation 'Real world' emissions test	Page 49
10.	The chattering relay	Construction details	Page 56
11.	ESD test setup.	General requirements Setup for mains powered equipment	Page 57
12.	Conducted RF testing.	Equipment and setups	Page 58
13.	Ambient signals	Frequency list of the common sources of background interference	Page 60

## Introduction

This is a comprehensive description of how to test product compliance in a pragmatic and cost effective manner. It assumes that the resources and facilities available to the test engineer are limited, as is normally the case when manufacturers are intent on self testing during product development, pre-compliance testing and even final compliance tests. The testing strategies described herein have been refined over many years and have proved to be effective in spite of the influence of background noise, limited space and resources.

These notes are intended to accompany the training course provided by Laplace and will act as an 'aide memoir' when beginning to test products when back at base.

EMC has had a reputation for being a 'difficult', complex topic that requires years of experience to master. One of the purposes of these notes is to dispel that impression and show that once some simple fundamentals are grasped, the rest is quite straightforward.

The content has been kept as concise as possible, with explanatory sections provided as Annexes.

## The EU Directive

The EMC Directive (2004/108/EC) essentially states that before any **product** is sold in the EU, the **supplier** (who may be the manufacturer or the importer) must ensure that it will not cause interference (**emissions**), and that it will operate satisfactorily in its intended environment (**immunity**).

Test techniques to check the various aspects of emissions and immunity are specified in the **EMC Standards**. These are the compliance tests. These standards include details of the maximum allowable levels of emissions, and the immunity 'stress' levels that must be applied.

## The Standards

There are many EMC standards. Many emissions standards are 'product specific' and apply to a particular type of product only. Some are 'generic' and apply to any products not covered by a product specific standard. Immunity standards are generally common to all products, and the 'stress' levels are varied according to the environment in which the product is to be used (eg. residential or industrial or medical or automotive..etc...) Each product must be tested using the relevant standard. It is the responsibility of the supplier to select the appropriate standard(s).

The standards mentioned in these notes are the EU commercial standards. These are applied throughout Europe. Military and Automotive standards are also available as relevant. Outside Europe, many major territories have their own standards. US, China, Japan and others have all developed their own versions. In Australia/NZ the EU standards are used, but they were given different standard numbers. But recently they seem to have reverted to the EU numbering system.

Some of the most common standards are:

<b>Emissions</b>	<b>Type</b>	<b>Notes</b>
IEC61000-6-3	Generic emissions	Residential and light commercial. This replaces EN50081-1
IEC61000-6-4	Generic emissions	Industrial. This replaces EN50081-2
IEC61000-3-2	Harmonics (Mains)	Up to 16A/phase
IEC61000-3-3	Flicker	Up to 16A/phase
EN55011	Industrial equipment	
EN55013	Broadcast receivers. (radios, TVs..)	
EN55014	Domestic appliances, Hand held products	Up to 300MHz
EN55015	Luminaires	Includes band A
EN55022	ITE equipment	See Annex 3 for upper frequency limit.
EN55025	Automotive	
<b>Immunity</b>		
IEC61000-6-1	Generic immunity	Residential and light commercial. This replaces EN50082-1
IEC61000-6-2	Generic immunity	Industrial. This replaces EN50082-2
IEC61000-4-2	ESD (Electro Static Discharge)	Up to 8kV or 16kV
IEC61000-4-3	Radiated RF. Requires cell, chamber or screened room.	Industrial, up to 10V/m. Some standards (eg medical) are higher.
IEC61000-4-4	EFT (electrical fast transients)	
IEC61000-4-5	Surge	
IEC61000-4-6	Conducted RF	Applied to all cables connected to EUT
IEC61000-4-8	Magnetic field (power frequency)	Normally only applied if EUT operates in high magnetic field environment.
IEC61000-4-9	Magnetic field (pulsed)	As above
IEC61000-4-11	Voltage dips & interruptions	Any mains powered equipment.

Once a supplier is confident that the product is compliant, they can produce a Declaration of Compliance, sign it, create a compliance file and add supporting test results and explanations. Then the CE mark can be attached to the product and then it can be sold in the EU.

*Note that all this is the responsibility of the supplier, this responsibility cannot be delegated to a test lab or any other third party.*

*This is the whole point of 'Self Declaration'.*

The 'authorities' assume (probably correctly) that the supplier is best positioned to judge EMC compliance, to know what environment the product will be subjected to and to know best how to 'cure' any issues that might arise. Compliance cannot be delegated to any other party, including test labs. The supplier is totally 100% responsible for the EMC characteristics and compliance of the product.

### **Compliance testing strategies**

In order to judge compliance, some tests/measurements would be advisable. The selection of which tests to make is a decision for the supplier. Some tests may be regarded as unnecessary. The supplier decides! In the case of emissions, measurements are virtually always needed, especially those for radiated emissions. This is because (a) the 'victim' is some innocent third party and (b) compliance can only be judged by measurement.

Regarding immunity, if the product is 'safety critical' then 100% rigorous testing is really essential... nobody wants to run the risk of liability claims. Other, relatively

benign products, might not need such formal testing. Immunity tends to be 'self policing' in that if there was an immunity issue, it would impact on reliability and it's a good bet that the product customers will let the supplier know all about it at some length!

The emissions case.....

Your emissions **J** —————> **L** innocent victim

The immunity case.....

Regular 'noise' **(** —————> **L** Your customer

In the old days of the DTI, they issued a circular which suggested that manufacturers should not incur excess costs due to unnecessary testing. So be pragmatic. Some immunity tests can be simulated at very little cost, and these can be quite realistic. Provided any tests and their rationale and justification are described in the compliance documentation, then (provided these are based on sound engineering judgements) you can claim you have fully followed the spirit of the Directive.

As regards the testing the supplier may....

- use a test lab
- use a consultant
- use 'in-house' testing
- or a combination of the above

All are perfectly eligible. The choice is one of economics.

If a company has some in-house expertise and one product per annum to test, then the test lab strategy may be sensible.

If no in-house expertise is available, then a consultant, maybe in combination with a test lab, would be appropriate.

If several products per annum are to be tested, then in-house testing will offer many cost and timescale benefits. Even if only 'pre-compliance' testing before submitting the product to the test lab, the benefits can be significant.

### Pre-compliance testing and pre-compliant test equipment

There is considerable confusion about the term '*pre-compliance*'.

'*Pre-compliance*' is a **strategy**. It is the testing of a product before submitting it to a test lab (or other) for a 'formal' test. It is also the testing of development prototypes and/or sub assemblies during the design phase of a new product.

It does **not** refer to the test equipment. ....There is no such thing as '*pre-compliance*' test equipment... instead there is '*compliant*' test equipment and '*non-compliant*' test equipment. This compliance relates to **CISPR16**. This is the standard that specifies the test equipment that is used for EMC testing. So it defines the analysers, LISNs, receivers, as well as antennas and all the other auxiliary items. Note that CISPR16 also applies to test sites and their calibration. The use of fully *compliant* test equipment is of little use if the test site itself is non-compliant! (In fact, it is the test site that contributes by far the greatest source of measurement uncertainty when

measuring radiated emissions. So the insistence on ‘compliant’ test equipment offers little benefit unless using a compliant and calibrated test site).

The EMC Directive gives manufacturers and suppliers of products the responsibility to ensure that the products are compliant. There is no insistence on the use of ‘compliant’ test equipment. Provided that testing is done honestly, with due diligence and the results are such that any competent engineer would judge that the product meets the requirements of the standard, then that is adequate basis for declaring the product is compliant.

### Some background basics

The EMC frequency bands are shown in table 2.

Band	Start Frequency	End Frequency	Type
A	9KHz	150KHz	Conducted
B	150KHz	30MHz	Conducted
C	30MHz	300MHz	Radiated
D	300MHz	1000MHz	Radiated
E	1000MHz	-----	Radiated

Note the change at 30MHz from conducted to radiated emissions. For an understanding of this apparently arbitrary frequency for this changeover, see [Annex 1](#). This Annex also explains how radiated emissions are generated and transmitted.

Receivers vs analysers.....The standards specify the use of a ‘receiver’ for the measurement of emission levels. Many users however, use an ‘analyser’, rather than a receiver. These two instruments have many common features. The key difference between a receiver and an analyser is that the receiver has an additional section, a ‘pre-selector’. The pre-selector enables the receiver to handle and measure certain types of signal more accurately. Specifically, if the incoming signal includes significant broadband component, then the pre-selector should be used. In the absence of broadband components, both types of instrument will deliver the same result. A full account of the pre-selector issue is given in [Annex 2](#).

The Laplace EMC analysers have a pre-selector as an optional extra.

Wavelength.....When dealing with radiated emissions, it is often helpful to think in terms of wavelength rather than frequency. Any conductor (cable, PCB track, PCB length) will become a very effective radiating aerial at quarter wavelength long. Any slot in a screened enclosure or front panel becomes an effective aerial at half wavelength. An easy way to remember the relationship between **frequency and wavelength** is that 300MHz has a wavelength of 1 metre. The relationship is inverse, the higher the frequency, the shorter the wavelength. So 30MHz has a wavelength of 10m and 600MHz has a wavelength of 50cm.

300MHz ..... 1m

200MHz ..... 1.5m

100MHz ..... 3m

50MHz ..... 6m

For example, FM radio transmissions are around 100MHz, so the ideal length of the wire coathanger to stick in the car antenna socket is  $3\text{m} * \frac{1}{4} = 0.75\text{m}$ .

If you have a 1.5m mains cable connected to the product, this is  $\frac{1}{4}$  wavelength for a  $6\text{m} = 50\text{MHz}$  signal. So be sure to check for emissions at this frequency.

EUT and AE..... These terms are frequently used in the EMC field.

**EUT** = Equipment under test. The product that is being tested.

**AE** = Associated Equipment. Equipment that is connected to the EUT in order that the EUT can operate as normal, but is not itself to be EMC tested.

Traps for the unwary....

1. Once compliance has been obtained for a product..... be very careful to ensure that the build standard is not changed. Even moving some cables internally (for example, to tidy the design), can affect emission levels. So ensure that compliance testing is done on a fully representative production standard product.
2. Never make assumptions. Always test the product in all its modes of operation. Some products have been known to fail when in standby mode.
3. Small, low power products can be just as noisy as large high power items.
4. Good immunity does NOT imply good emissions, or vice versa.
5. RF is NOT like DC or audio frequency signals. By its very nature, RF wants to radiate from conductors, couple to surrounding structures and treats wires of any significant length as open circuits. (see [Annex 1](#)). So the test setups that are specified in the following tests can be critically important even if the rationale at first sight seems counter-productive. Be very careful, specially regarding cable routings, grounding and ground planes.

## The test requirements

### The Emissions tests

**Conducted.** Interference that is conducted from the EUT down a cable(s) to the victim. So typically, this covers the case where the path from the source to the victim is via the mains distribution system. This requirement covers the frequency range 9KHz to 30MHz, although band A (9KHz – 150KHz) is not specified in most standards. So most products only need conducted emission testing in band B. (150KHz – 30MHz).

**Radiated.** Interference that is transferred through ‘free space’ between the EUT and the victim. For the majority of products, this requires testing for band C and D ... ie. 30MHz up to 1GHz.

Note 1. Some standards are now specifying higher frequencies. EN55022 which is a basic standard now requires 1GHz or the fifth harmonic of the fastest clock in the product, whichever is the highest, up to a maximum of 6GHz. [See Annex 3](#).

The basic procedure is based on the ‘antenna on an OATS’ technique.

Note 2. EN55015 for luminaires has been changed (2010) so that radiated emission testing 30MHz – 300MHz is required. They have replaced the ‘antenna on an OATS’ technique with a technique that measures the interference signal that appears on the cable(s) exiting the product. This covers the band 30MHz – 300MHz. This is a form of conducted emission testing which (it is claimed) approximates to a radiated emission measurement. The great advantage is that it is a far simpler technique and offers better repeatability. [See Annex 7](#).

Harmonics & Flicker. These relate to the way in which the product draws current from the mains supply. Modern electronic products and even items such as lighting equipment tend to draw their current in a pulsed manner, rather than smoothly. This means that the current waveform contains significant harmonics of the power frequency, which is 50Hz in the EU. The unwanted harmonics appear at 100, 150, 200, 250..... up to 2000Hz. The problem is that the mains distribution network is not designed for these higher frequencies, it becomes less efficient and more prone to failure. Hence the real need to restrict the level of these harmonics. Flicker is another measurement of the mains supply to the product. It may or may not be required. Most products cannot cause Flicker, and the standard includes a statement to the effect that if the product is unlikely to cause flicker, then flicker testing is not required. See [Annex 4](#).....

### The Immunity tests.

#### The common tests.

These tests simulate the stresses that a product may encounter in the 'real world'.

IEC 61000	Test	Simulates
-4-2	Electrostatic discharge	A person walks across a carpet, becoming electrically charged, then touches the product, discharging that stored energy as an intense current transient through the product.
-4-3	Radiated RF.	Someone uses a mobile phone when stood right next to the product.
-4-4	Electrical fast transient.	An adjacent load is switched off causing a high energy voltage transient in the mains supply.
-4-5	Surge.	A nearby lightning strike causes a surge on the power lines.
-4-6	Conducted RF	Ambient RF signals are induced into cables and/or connected products transmit RF interference.
-4-8	Magnetic field (power freq.)	High power electrical systems including transformers and electric traction systems (railways).
-4-9	Magnetic field (Pulsed)	Medical and heavy industry.
-4-11	Dips and interrupts (AC)	Brownouts and momentary outages on the mains due to faults and switching transients.
-4-29	Dips and interrupts (DC)	Glitches on DC supplies.

These tests apply to any commercial product. Additional tests are required for certain types of product that may be used for military, automotive, aerospace, medical and other specific applications.

For each test there is a stress level to be applied. These levels depend on the normal operating environment and function of the product. Typical environments with increasing stress levels are domestic, industrial, medical and automotive.

### Compliance criteria

The pass/fail criteria also vary according to the type of product.

Performance criterion A pass means that the product exhibited no degradation in performance or loss of function at any time.

Performance criterion B pass is a momentary degradation in performance, but operation recovers and continues as normal when the stress is terminated.

Performance criterion C pass means that the product stopped operating and required manual intervention to recover normal operation (eg, power cycling).

For all criteria:

- data integrity must be maintained, and no data lost.
- there is no damage to the product.

Any safety critical product must achieve Performance Criterion A.

### Low cost testing

For some obviously non-critical products, simple, pragmatic tests could be justified thus avoiding the expense of formal testing. For example...

- A mobile phone used right next to the EUT
- Momentary interruption of the mains supply with a switch.
- Use of a variac to simulate brownouts.
- Use of a 'chattering relay' to simulate broadband RF and impulsive noise. (see [Annex 10](#))
- If the product has been in volume use for some time, the fact that no problems have been encountered could be used as a part of the justification for compliance.

The argument that because a product has low emissions characteristics, its immunity characteristics must be good too.... Does **NOT** apply!

### ESD test (IEC61000-4-2)

For most products, this test is all about the discharge CURRENT path. An ESD simulator is essentially simply a 150pF capacitor charged to the specified voltage (typically 4 or 8 or 16kV), discharged via a 330R series resistor either by contact or air gap to the EUT. The discharge current must find a route back to the gun. The test setup specifies that the ground connection to the gun is securely bonded to a ground plane on the floor. This ground plane is connected to the EUT earth. This typically ensures that the return loop is via the earth connection on the EUT. Modified arrangements apply if the EUT does not have an earth connection, or has no metallic contact points.

See [Annex 11](#) for more details.

### Radiated RF immunity (IEC61000-4-3)

The product is 'immersed' in a strong RF field which is swept over the range 80MHz to an upper limit. This upper limit is specified in the relevant standard, as is the stress level (V/m). Many standards have an upper limit of 1GHz, but some do go higher.

Products for domestic environments are tested at 3V/m, for industrial, 10V/m and medical, automotive and others can be higher.

Such strong fields must be contained, otherwise local reception of intended transmissions (including radio, TV, emergency services) would suffer appreciable interference. So this test is always conducted in some kind of chamber or cell.

The standard specifies that the frequency is stepped in increments which are a percentage of the current frequency. The step size can be decided by the manufacturer, but is generally up to 1%. (80 – 1000MHz at 1% step is 256 points, at 0.5% step, we have 971 points). At each frequency there is a pause whilst the EUT is checked that it has not failed. This is the dwell time. During this dwell time the RF is modulated. 1KHz am modulation is specified at 80% depth. At some frequencies (the mobile phone bands) 200Hz pulsed modulation is required too.

If the dwell time is 3 seconds and the frequency range is 80MHz – 1GHz, the time for the test at 1% step will be around 30 minutes, for 0.5% step it will be around 100 minutes. Some means of automatically monitoring and logging the EUT is clearly an advantage in order to avoid the need for an operator to continuously watch the product for the whole test.

The product should be tested in its normal operating mode(s), complete with appropriate peripherals. It is normal to keep the peripherals outside the test volume and connect via filtered feeds through the cell/chamber wall. Adequate feeds are need therefore to be specified with the supplier of the cell/chamber.

All 3 axes must be tested. This means that if a cell is used, the internal volume must be large enough to be able to rotate the EUT (with its associated cables) through all three axes. Note that test cells normally apply the field with vertical polarisation only.

	Test cell	Test chamber
EUT size	Limited. Generally 19" rack size is about the maximum, although larger cell are available.	Can be very large. Whole vehicles can be tested in large chambers.
RF power required	Relatively low power levels required. Cells tend to be very efficient.	High power required.
Cost	£15K - £30K	£70K upwards

In addition to the cell/chamber the following is required:

- Signal generator
- RF amplifiers
- RF switching unit
- Field probe
- Control system
- Software
- EUT monitoring system
- Antenna (if using a chamber)

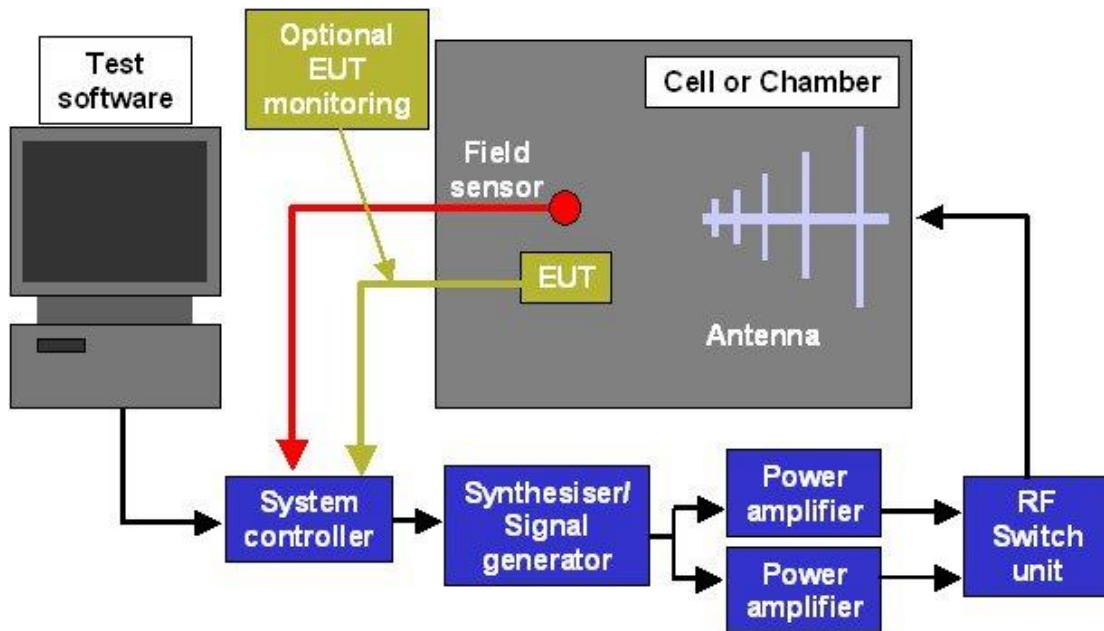

Note:

1. There are 2 power amplifiers shown because power amplifiers either cover 80MHz – 1GHz, or 1GHz upwards. There are no PAs that cover the whole range as a single unit. So if the range 80MHz to >1GHz is required, 2 power amps are needed.
2. The field sensor is shown. If a LaplaCell is used, the field sensor is included with the cell and is not a separate item.

This is a closed loop control test. When the test is running, the field sensor feeds the actual field level back to the control system. This is used to set the signal level from the signal generator so that the required stress level is maintained.

There are 2 strategies employed for this control technique.....

- Pre-scanned. The EUT is substituted for the field sensor. The scan is run with the EUT outside the chamber/cell. The control system logs the settings necessary to achieve the required set level. The sensor is then substituted by the EUT and the same settings are then run.
- Direct. The test is run without the pre-scan, with the field sensor placed alongside the EUT and used to control the level directly.

In general, the pre-scanned technique is preferred.

#### Electrical fast transient (IEC61000-4-4)

The transients are bursts of pulses applied at 5KHz and/or 100KHz rate, for a duration of 15ms, repeated every 300ms. The amplitude of the pulses is specified by the standard. These pulses are injected either via a **CDN** (for power feed) or a capacitive coupling clamp (for other cables) on to the relevant cable (or **Port**). All tests are conducted in common mode with reference to ground. The EUT must be fully connected as in normal operation. Each cable is tested in turn. The cables that are not being tested should still be fitted with the CDN/Coupling clamps. The whole setup should be placed on a ground plane and spaced 10cm above it. In many respects, the test setup is similar to that for the RF conducted immunity test.. see later. Any Associated Equipment (AE) is protected via decoupling networks.

### Surge (IEC61000-4-5)

The surge test applies a single high energy pulse to any cables connected to the EUT ports. In this case, the tests are applied both with reference to ground, and line-line (in which case the surge generator output is 'floating'). CDNs or capacitive coupling clamps are used to inject the surge. In the case of power lines, the standard specifies the phase angles at which the surge is applied. Normally up to 10 surges are applied, 5 of each polarity, to avoid any unnecessary damage to the product. Any Associated Equipment (AE) is protected via decoupling networks.

### Conducted RF immunity (IEC61000-4-6)

See [Annex 12](#)

As with the previous two tests, the stress is applied to all EUT ports via the cables normally connected when the product is in service. In this case the stress is an RF signal, typically 10v level in the range 100KHz to 230MHz. At the upper end of this frequency range, great care must be taken to ensure the test setup is correct, with all ground plane bonding rigorously applied.

### Dips and interrupts (IEC61000-4-11 and -29)

These apply to both mains and DC supplies. They simulate 'brownouts' (dips) and short term interruptions. The dips are specified for percentage drop and duration and the interruptions are specified in terms of the number of cycles.

The generic requirements are:

- 70% of nominal voltage for 25 and 50 cycles.
- 40% of nominal voltage for 5 and 10 cycles.
- Interruption for 0.5 and 1 cycle.

## **Emissions testing procedure ... conducted**

The emphasis until recently has been the measurement of the interference transmitted back from the product (Equipment Under Test) down the mains power lead. Now however, emissions from other 'ports', including telecomms ports have to be measured (see EN55022:2006).

### **Power lines**

The aim of the test is to measure the amount of *interference power* transmitted from the EUT. The normal technique is to use capacitive coupling to each power line so that the voltage component of the interference signal can be measured. However, this is only half the story. In order to measure power, current needs to be measured too. In practice, it is easier to provide a known and stable load impedance so that interference power can be deduced from the voltage measurement and an application of Ohm's law. This technique is embodied in the LISN (Line Impedance Stabilisation Network). The LISN includes the capacitive coupling network and the impedance stabilisation network (which provides a stable 50ohm impedance across the relevant frequency band). Most commercial LISNs also include a '*transient limiter*'. This is to ensure that no high energy impulses are allowed through to the receiver of analyser. Such pulses may be generated by any mains switching event in the immediate locality (eg next door) and may be powerful enough to damage the sensitive input on an analyser.

LISNs are specified in terms of EUT current rating, number of lines and frequency range. A standard single phase LISN will have 2 lines (L, N) and a three phase LISN will normally have 4 lines (L1, L2, L3, N).

Frequency range is normally band B, but band A+B LISNs are available when required.

### The setup

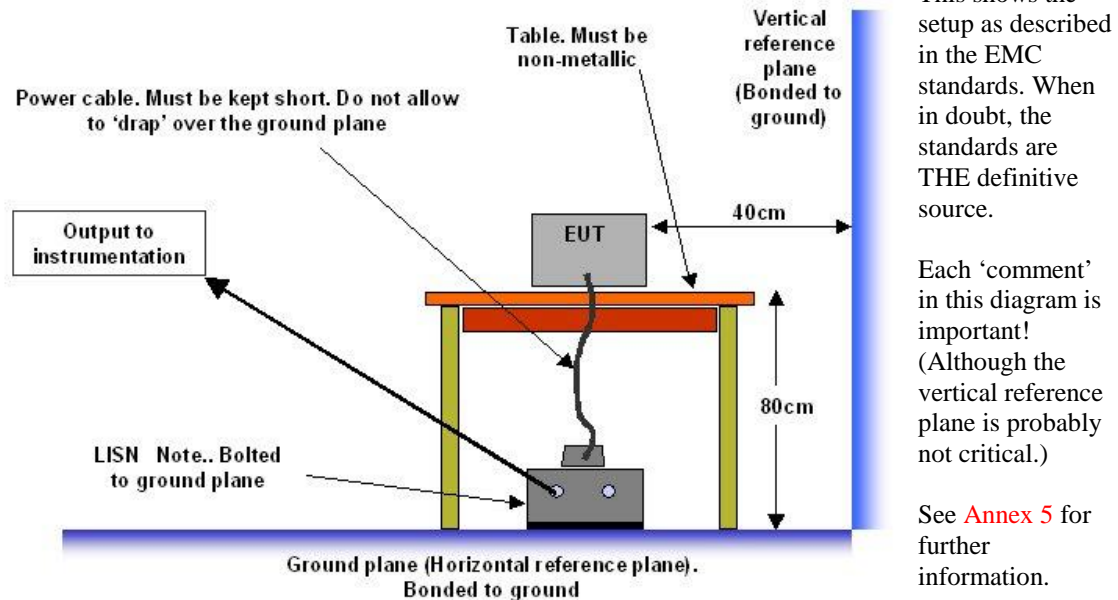

### Connections..

The diagram shows the connections when using a Laplace analyser with an optional pre-selector. Other systems will connect in a similar fashion.

Without the pre-selector, the LISN output (Co-ax feed) may be connected direct

to the analyser, using the Pre-amplifier if required. Note that the pre-amplifier is positioned AFTER the pre-selector if the pre-selector is used.

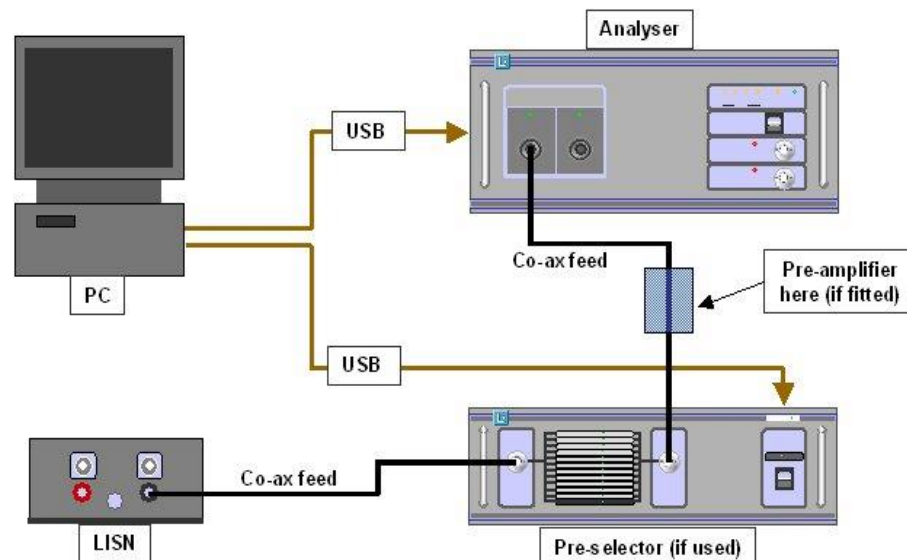

Once the setup is ready., measurements can start.

The conducted emission standards will provide a table to show the limit levels that are acceptable. Any EUT must show results that are 100% below the relevant limit in order to be considered compliant.

The table will have two sets of limit levels, labelled Quasi-Peak and Average. These relate to the type of 'detector' used in the analyser. All EMC analysers and receivers are fitted with 3 (or more) 'detectors' .. Peak, Quasi-peak (QP) and Average. See [Annex 6](#) for a full explanation of these detectors.

The basic procedure is then:

1. Ensure all is connected and the software is set correctly:
  - a. Frequency range
  - b. attenuator to maximum (30dB)
  - c. input device (LISN) selected in the software
  - d. detector set to Peak.
  - e. relevant limit selected
2. Plug the EUT into the LISN, but keep the EUT switched off.
3. Scan the analyser to measure the background level (which should be very low).
4. Reduce the attenuator progressively, scanning each time. Normally 0dB attenuation can be reached without any significant noise observed.
5. Store the final result for the background (>STORE).
6. Return to max attenuation and switch the EUT on.
7. Scan with the analyser and use the following compression detection procedure to optimise the attenuator setting.....
  - a. Scan, and when completed...
  - b. Click on >STORE to copy the current trace to the Store trace.
  - c. Reduce the attenuation by 10dB and scan again.
  - d. Compare the last scan (current trace) with the previous trace (store trace). If these traces are essentially the same (apart from the base line) then this indicates that the analyser is not in compression. Repeat from a. above. If the traces do show significant differences, the analyser is probably in compression, in which case, increase the attenuation by one step and then continue with step 8.
8. The current trace will be the emission levels from the EUT. If these are all below the lowest (Ave) limit, the product is compliant. Save and print the result. The task is now completed. If the levels are anywhere above the Ave limit, then further testing is required.....
9. The fact that the peak detector result is over the limit(s) does not mean that the product fails, it simply means that the QP and Ave detectors must be now used. The reason why these are not used in the first place is that they are SLOW. The QP and Average detectors are specified with time constants such that the analyser must 'dwell' at each frequency for a significant time whilst the detectors settle, before taking the reading and moving on to the next frequency.

It is likely that the Peak results exceed the limit at only certain bands or specific frequencies, so it makes sense to only look at those points. The analyser has a 'Marker' facility which allows the placement of up to 20 Markers. Using this facility, place markers on the problem frequency points. These can be presented in either tabular or bargraph format.

10. When the markers are located, select 'All Detectors' under the Detectors menu and then click on the Marker Pts button. If using the Bargraph presentation, there are two sets of results. By clicking on the radio buttons to the right of each set they can be made to show QP and Ave results. The display is 'normalised' such that the mid level is always at the limit level. The compliance at each point is immediately shown by colour.
11. Any changes to the EUT that affect the emissions can be immediately seen in the Marker Pts mode.
12. The full details of the marked frequencies can be listed if the Print facility is used in the tabular marker screen.
13. When the 'problem' frequencies are cured. Return to the scan. It is good practice to do further complete scans with the Peak detector to ensure that any changes to the EUT which reduced the levels at the marked frequencies have not resulted in increases elsewhere.
14. If all now looks good, and if required, do a complete scan with all three detectors as the record of the full and final measurement.

### **Emissions testing ... radiated**

There are 4 test techniques specified in the standards.....

- Antenna on an OATS (as used by most standards)
- RF absorbing clamp (specifically used with EN55014 – appliances)
- Large Loop Antenna (specifically used with EN55015 – luminaries)
- CDN (used in EN55015 and for telecom ports in EN55022)

Plus one that is commonly used, but not included in the EU standards...

- Test cell or chamber.

#### Antenna on an OATS.

At first sight, this should be an easy test.

Just stand a calibrated antenna a certain distance from the EUT and measure the signals received... what could be easier!

There are 2 'difficulties'.....

#### 1. Ambient.

Anywhere you may decide to conduct the test, there will be lots of RF signals already present, and some of these will invariably be well over the EMC limits. Such signals include 'intentional' transmissions (TV, FM, Mobile phones, ... etc, see [annex 13](#)) and 'noise' such as often present in industrial sites from machinery, lighting, computer equipment, etc..) This 'background' or 'ambient' can obscure the relatively weak signals from your EUT.

See [Annex 8](#).

#### 2. Test site configuration.

Two of the problems with RF are that (a) it reflects, and (b) two RF waves that arrive at an antenna 180 degrees out-of-phase will cancel each other. These two characteristics can cause serious problems. In the simplest case, with the test site out in the middle of an open field, there will be just one 'direct' signal and one reflected off the ground. The reflectivity of the ground is an unknown variable and this will determine the strength of the reflected signal at the antenna. At the antenna there will

be the direct signal and the reflected signal. These are from the same source, so are coherent and will mutually interfere. The reflected signal will have travelled further than the direct signal, and the phase relationship between the two will be determined by the difference in path lengths. For example, if the reflected path length is 0.5m longer than the direct path, and the EUT is radiating a 300MHz signal (1m wavelength) then the two signals will be 180 degrees out of phase at the antenna, and will cancel each other. This will result in a reading of the 300MHz signal much lower than it should be.

The standard overcomes this issue by specifying that the tests must be done on an OATS (Open Area Test Site) and...

.... to cover the ground with a metal sheet, so that the reflection coefficient is consistent and fixed at 100%

.... To height scan the antenna (1m to 4m) so that the measurement can always be taken when the two signals are in phase and the signal level is at its maximum.

See [Annex 9](#).

The Laplace system provides solutions to both the above problems. The problem of background signals is solved by using ambient cancellation techniques and the test site calibration issue is solved by using a reference source.

**See later for the procedure.**

#### RF absorbing clamp (specifically used with EN55014 – appliances)

This technique is only allowed for certain products, in which (generally) they only have a power cable. Such products are household appliances and hand tools. The rationale is that the cable will act as the radiating antenna, and that the emissions from the product itself will not be dominant. (a reasonable judgement in most cases). The advantage of this approach is that the test technique avoids all the issues explained above for the 'OATS + antenna' technique. The absorbing clamp couples any RF present on the cable to an output that can be measured with an EMC analyser.

Although the technique sounds fine in theory, significant discrepancies have been found between results obtained with this technique, and comparable measurements on an OATS.

Due to the likelihood of mismatches in the cable impedance at RF frequencies at the remote end of any cable, reflections will occur, producing 'standing waves' along the cable. Therefore the test requires a long cable to be used, and the clamp to be fitted with wheels so that it can be easily moved along the cable, looking for maxima.

#### Large Loop Antenna (specifically used with EN55015 – luminaries).

The standard requires measurement of magnetic field radiated in the band 9KHz – 30MHz. This is accomplished with a large loop placed round the EUT.

The test is only required for luminaires with an operating frequency well above the mains frequency. (eg as with high frequency electronic ballasts).

Usually, the loops are 2 metres in diameter and are supplied as a set of three to cover the three axes round the product. Each axis is measured and all must comply with the standard. This is a simple and straightforward technique.

#### CDN (used in EN55015 and for telecom ports in EN55022)

CDN stands for 'Coupling Decoupling Network'. These are devices originally designed for use in RF immunity testing. They enable an RF signal from a signal

generator to be injected into a cable connected to the EUT.

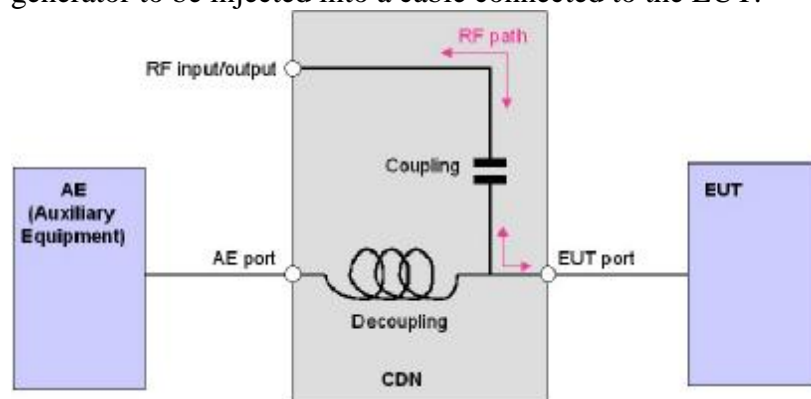

The figure shows the general arrangement. When immunity testing, the injected RF is coupled into the cable and the EUT, but is blocked from affecting the AE, thus enabling the EUT to operate normally whilst the stress is applied. For emission measurements, the same CDN is used but this time the RF is travelling in the opposite direction, away from the EUT, and the RF port on the CDN is connected to an EMC analyser.

The frequency range for emissions work is 30MHz – 300MHz.

This is now specified as a requirement for EN55015 (luminaires). Again, the standards committee are trying to avoid the issues that plague the OATS+Antenna technique. It is also part of the solution for telecomms ports on other products, although the standards have not yet become fully formalised and stable. There are currently 3 or 4 ‘suggested’ techniques See annex C in EN55022 for details.

There are 5 basic ‘varieties’ of CDN, according to the type of cable to be tested.

Type M,	Mains (2 and 3 line for single phase, 4 and 5 line for 3 phase)
Type AF,	unscreened cables. Number of cores must be specified
Type S,	screened cables
Type ST,	screened telecom cables. (eg Ethernet, twisted pairs)
Type T,	unscreened telecom cables.

Unfortunately, CDNs are made to suit each individual cable type, so ST8 is correct for a 4 x twisted pair cable, but for a 2 x twisted pair cable, a different CDN, the ST4, must be used. However, with the Laplace ‘versatile’ range of CDNs, each CDN can be used for a variety of cables, eg the ST8 model will cope with ST4, ST2 and ST1.

### Test Cell or chamber.

This is a technique derived from the OATS + Antenna method. The aim is to simulate an OATS in an enclosed and screened space such that:

- ambient noise is eliminated
- the calibration of the cell/chamber is correlated with a standard OATS.

There are significant advantages in using these devices, but the accuracy is always suspect due to the coupling between cables (always variable according to the EUT and cable configuration) and the structure. For this reason, they are only used (officially) for pre-compliance testing. However, FCC in the USA does allow the use of these devices for compliance measurements, and many test labs in the EU also use them due to their ease of use and speed of testing.

## Procedure for radiated emissions test.

This describes a recommended procedure for measuring radiated emissions using an antenna on an approximation to an OATS.

This technique assumes that you have a typical test site, ie it is not an open site but may be indoors and will suffer from the proximity of reflecting objects.

Ambient noise is prevalent.

There is no ground plane.

There are no facilities for height scanning.

### Overview

- Measuring equipment.
- Test site preparation.
- Initial 'pre-scan'
- Initial measurements.
- ERS scan.
- Application of ERS corrections.

**w** The equipment that it is recommended for these measurements would comprise:

- EMC analyser (SA1002 or SA3000) with PC software
- RF200 antenna and stand
- SA1020 pre-amplifier
- ERS emissions reference source
- RF100 near field probe set.
- 5m BNC - BNC cable

**w** Site preparation:

- It is worthwhile to make the site as good as is reasonably possible. The better the site, the quicker and easier and more accurate the measurements.
- The key issue is the proximity of anything metallic which can reflect RF. The ideal is the middle of a football pitch, and the worst case is a screened room. Generally, actual sites are somewhere in between, but the more 'open' the site, the better. So a car park or a large room or space indoors are reasonable solutions.
- One situation that must always be avoided is the use of any significant metal elements in the bench or table on which the EUT is mounted. Any emissions from the EUT will be coupled into these items and re-radiated. If the element happens to be half wavelength of the EUT frequency, it could cause a significant error in the measured signal.
- Do not use a ground plane.
- Site the antenna pointing towards the EUT such that the reference point (the location of the central vertical mounting point) is 3m away from the nearest point on the EUT. The height of the antenna is not significant, but be sure to use the same height for all tests.
- Use vertical polarisation initially. (antenna elements vertical).
- Mount the SA1020 pre-amplifier on the antenna using the supplied Velcro.
- Ideally, run the BNC-BNC cable off to one side with the EMC analyser near the limit of the cable length.
- Cables from the EUT should drop to the floor and run away from the antenna.

- Ensure that there are no other products similar to the EUT running in the vicinity. These will mask the EUT emissions.
- The site must be stable. When taking the scans, nothing (including the test engineers) should move until the test sequence is completed.
- The EUT should be capable of running in any/all of its modes.

#### W Initial 'pre-scan'

If significant ambient is present (and it almost always is) then it is useful to know what EUT frequencies we need to look for. Near field probes are a useful tool in this respect. So once the EUT is setup on site, use the H field probe, connected via the SA1020 pre-amp and the 5m cable, to scan the EUT (running) for emission frequencies. Set the analyser for peak detector and one step/RBW (under Advanced Setting). Do several scans with the probe located adjacent to any cables connected to the EUT, and to any slots or holes or any non-metallic parts of an case or enclosure, including display screens. Make a note of the frequency of any significant peaks and the probe location at which they appeared. These results could also be saved to disk as they are acquired.

At the end of this process, you should have a table of emission frequencies and locations. These are the frequencies to look for when measuring the emissions with the antenna. Any frequency not on this list must be ambient and can be ignored.

#### W Initial measurements.

Set the attenuator.

The assumption is that the ambient will dominate the overall input signal level. So we can set the input attenuator with the EUT switched off. Leave the attenuator set to 30dB and click S/Sweep. On completion, set 20dB attenuation and click >Store.

Click S/Sweep again. On completion, check that the current trace peaks are similar to those of the store trace. If they are, then reduce the attenuation by 10dB and repeat the process. If there are significant differences, this is either due to a change in the ambient (quite possible... the ambient is often quite unstable), or due to the analyser being overloaded (suffering from compression). Repeated sweeps will prove whether the ambient is changing or not.

The aim is to set the attenuator to the lowest level without suffering compression. Generally, 10dB attenuation is optimum, but in noisy locations, 20dB may have to be used, and in quiet locations, 0dB may be possible.

Note that the 'Compression Warning' indicator is simply a warning that you need to check. It is not an absolute indication of compression.

#### Ambient scan.

Select Processing... average of 8.

Click on RUN.

When the 8 sweeps are completed, the scanning will stop and the current trace will hold a copy of the ambient emissions. Copy this result to the >store trace. Save this result to disk.

#### Product scan.

Switch the EUT on. Allow for any initialisation processes so that the EUT is operating in its normal operating condition.

Select Processing... average of 8.

Click on RUN.

When the 8 sweeps are completed, the scanning will stop and the current trace will hold a copy of the EUT + ambient emissions.

Save this result to disk.

EUT emissions may be obvious, but if not, use the Difference trace and switch the Current and Store traces off. This difference can be compared directly with the limit line (bearing in mind that this is a peak detector result, not a QP result). Check that all peaks that seem to be due to the EUT are in fact so by checking the frequencies against the list obtained with the near field probe. Any peaks that are not listed are probably due to ambient. This can be checked by using the single frequency mode and observing the level whilst the EUT is switched off and back on.

If there are particular areas of interest, use zooming to examine in more detail.

The results will be subject to considerable error due to the test site. So any (all) EUT emission frequencies must be checked with the reference source (ERS) so that this error can be quantified and corrected.

#### w ERS scan

**See Annex 9.**

Replace the EUT with the ERS. Place the ERS such that the stem of the antenna approximates to the source of the emissions to be checked. If the EUT is radiating from two or more locations, then the checks with the near field probe will indicate which emissions are related to which locations.

It will save time, and make measurements easier, if the frequency span is zoomed so that just the observed EUT emission frequencies are covered.

Typically, this may be 30MHz – 300MHz.

It is normally recommended to increase the analyser attenuation by 10dB to allow for the fact that the ERS is a relatively strong source.

Once the ERS is positioned, switch it on and click on S/Sweep (no averaging required).

#### w ERS correction

When the scan is complete the amplitude of the ERS peaks at the frequencies of interest can be compared with the data given in the ERS calibration data. From this the correction can be calculated and applied to the EUT measurements.

Once this is done, the corrected measurements can be compared directly with the limits. Peaks of particular interest can be studied in detail by zooming, using Single Frequency mode or using the Marker function.

If there are two or more EUT locations of emissions, then the ERS correlation needs to be applied to each one.

Once all the above is completed, the whole sequence needs to be repeated for the horizontal polarisation.

### Use of other radiated emission measurement techniques.

The alternative techniques, such as the Large Loop Antenna, CDN, RF absorbing clamp and Test Cell are all far easier than the above procedure for the OATS. In general, ambient noise is non-existent and calibration is pre-loaded in the software. So the requirements for ambient measurement, the use of the difference trace, the need to use a reference source are all redundant.

Once the test configuration is set up and the appropriate input device selected in the software, the procedure becomes straightforward. Any scans will show any emissions from the EUT at the correct level for direct comparison with the limit(s).

<h3>Using the EMC analyser</h3>
---------------------------------

This is a check list to follow. This should ensure that the analyser is set correctly and appropriately for the measurement.

- Select the required frequency range.
- Select Log scaling for the frequency range.
- Inputs menu.....choose the correct input device.....
  - o Select the correct antenna distance if relevant.
  - o Select the correct type of LISN (insertion loss), if relevant.
- Limits menu.... Choose the correct limit.
- Select the relevant pre-amp gain.
- Select the detector required. (Pk or All).
- Add Project Title (under Display menu).
- Run the compression checks and set the input Atten/Gain level accordingly
- Use the **←** and **→** buttons to place the limit line 2/3 divisions up the screen.
- Use the RED master control buttons on the left hand side of the screen to take the scans. (S/Sweep or RUN)

#### Subsequent analysis tools

- Marker points mode, tabular and bargraph presentation
- 'Values' cursor
- Single frequency mode (with peak tracking option)
- Zoom

Any peak of particular interest can be studied with the single frequency mode, and the detector mode changed to suit. This enables the peak to be studied in real time with all 3 detectors plotted.

When thinking about radiation sources, remember to consider wavelength!

## Annex 1 Why not use near field probes to measure my emissions?

This is a question oft repeated by those trying to find a low cost method for judging compliance of their products. Most EMC test requirements for emissions are based on measurements of the RF field at a distance of 10m from the product. At this distance all sorts of 'difficult' factors become significant, such as background (ambient) signals, test site reflections, antenna calibration, ground plane and antenna height.

At first sight near field probes avoid these factors. It seems logical to assume that they provide an output proportional to the RF field strength radiated from a source... therefore it's logical to assume that this is a good measure of the radiation 'at a distance'. They certainly avoid the 'ambient' issue as near field probes (NFP) are relatively insensitive to far field radiation.

However, not only are the outputs from NFPs not proportional to the RF field at 10m, they can actually give entirely the opposite result to that intended.

To understand why this is so, we could (and should!) consult one of the many text books which are full of maths and Maxwell's equations... but personally I find all this theory quite incomprehensible..... and so to offer an insight as to exactly how this RF stuff is created and works, I try to reduce difficult stuff to 'pretty pictures'. So what follows is my own interpretation of what is happening. I do not pretend that it is rigorous or even correct, but it works for me and seems to explain other factors which otherwise seem entirely arbitrary. To start at the beginning..... what is the origin of this stuff called 'Electro-magnetic radiation' .....

Imagine a very simple circuit, as shown in fig 1.

We have a battery supplying a CMOS chip. This is being clocked at (say) 16MHz. When CMOS is dormant, it draws practically zero current, but at each clock edge, transistors change state and a small pulse of current flows round the supply circuit. Current in a conductor causes a magnetic field to be created around that conductor (we know that because this is how electric motors work). This magnetic field, which we call H, is proportional to the current flow. As soon as this small current pulse has passed, some

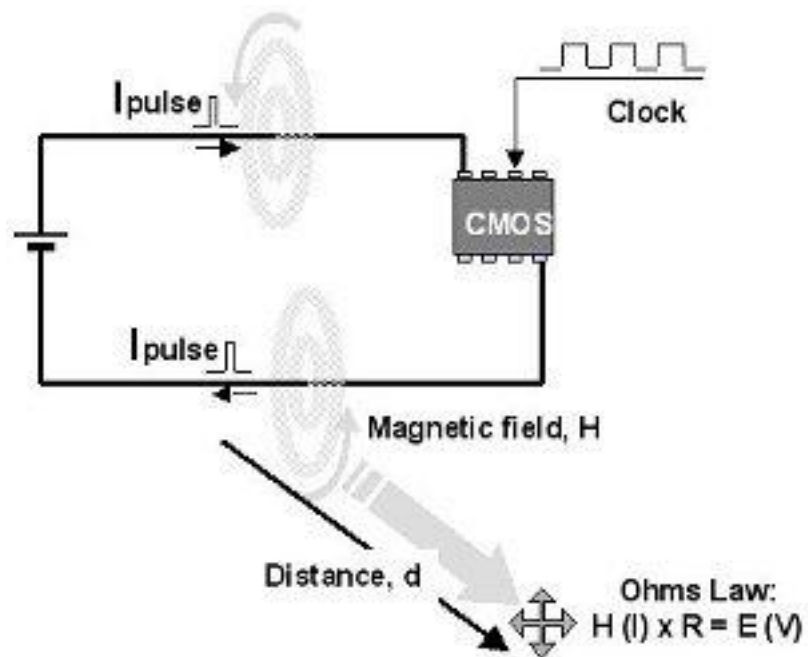

Fig 1. The classic source

of this magnetic energy decays back into the conductor in such a way that it opposes the next current pulse. In other words, the impedance presented to the next current pulse flowing down the conductor is increased. Here is the explanation of 'self inductance', the characteristic of any wire to become more 'resistive' as frequency is increased.

That part of the magnetic energy that has not decayed back into the conductor continues to radiate away into space. We can think of this energy as equivalent to current (after all, it was current that created it), flowing through a conductor called 'free space'. Free space has an impedance (someone actually measured it!), and its value is 377ohm. So now we have a

current (H) flowing down a conductor with an impedance (resistance) of 377ohm. Ohms Law ( $V = I/R$ ) now applies. There must be a voltage drop (E) equal to  $377 \times$  Current flowing (H). If the source was due entirely to current, the voltage at the source is zero and therefore the source impedance must also be zero (Ohms Law again). But at distance d, we do have a voltage component (E) and a current component (H) related by Ohms Law. This is our Electro-Magnetic Field.

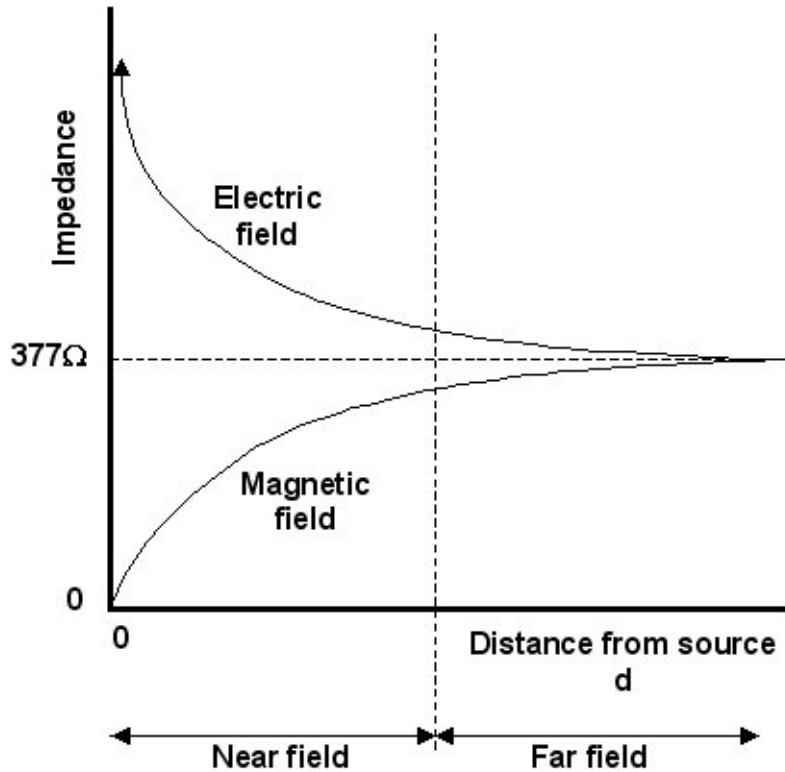

Fig 2. Field Impedance

We can plot field impedance vs distance from the source. See fig 2. The magnetic field starts from the origin with zero impedance, but gradually converts to a wave impedance of 377ohm as we move away from the source. The diagram also shows the corresponding effect due to an electric field source. These are not as common as current sources, but could be envisaged as shown in fig 3. Here we have an open circuit situation, so current flow is clearly not a factor, but voltage can be high... hence a high impedance characteristic.

Now, antennas are generally either E field sensors, or H field sensors. The classic dipoles and log periodics are sensitive to E field, not H field. If they are used in the far field, either type of sensor will give a true reading because the E and H fields are related by the 377ohm factor. If however we try to use an EMC antenna (which is sensitive to only E field) in the near field, and the source is magnetic, our E field sensor will not 'see' the emissions and you will have incorrect results. This is why the EMC standards specify a minimum antenna distance. If you read the small print, it states a minimum of 3metres.

The transition from near field to far field is clearly not clear cut. It is dependant on frequency. Different sources quote different distances, between one third of a wavelength, up to one tenth of a wavelength. Note that the lowest frequency

\*\* This prompts the question... why do the standards switch from conducted measurements to radiated measurements at 30MHz? It all stems from the fact that the impedance of a conductor increases with frequency. At dc, the impedance (resistance) of a length of wire is milliohms. As the frequency of a signal increases, this impedance rises. It so happens that at around 30MHz, the impedance of a typical wire is around 377ohm. Energy is lazy stuff and always takes the easiest route, so if you try to push energy down a wire at a frequency above 30MHz, then as far as this energy is concerned, free space appears as a lower impedance than the wire, so it takes the easiest route and radiates away!

quoted in EMC radiated

standards is 30MHz\*\*.

At this frequency the wavelength is 10m, so one third of this is around 3m, hence the instruction in the standards that the closest you should position the antenna to the product is 3m.



Fig 3. E field source

The strength of emissions that have reached an antenna at a distance from the source are dependent on several factors...

- The strength of the source.
- The radiating mechanism.
- The effect of any screening.
- The effect of filtering.
- The characteristics of the local environment.

If for pre-compliance purposes we cannot control the environment, and we use screening and filtering as potential mitigating techniques, then we are left with the first two factors. Of these, the 'radiating mechanism' (which in other words is the Aerial) is the dominant factor. Consider a taxi firm which has a radio transmitter in the back office with which to communicate with its fleet. The transmitter may be able to generate many watts of RF power, but if the aerial is disconnected, it will not be able to talk to a car even just round the corner. This makes it obvious that it is the aerial which radiates emissions, not the source. Near field probes are great for detecting the location and frequency of sources, but they give little information about the efficiency of the radiating mechanism, the aerial. So we can have a situation (and very frequently do) where the near field probe produces a really strong response from a source, but when that frequency is measured at 3 or 10m, the emissions are well below the limits. On the other hand, a source may appear quite feeble with the near field probe, but the emissions are well over the limits. The former did not have any effective antenna, but the latter had (by chance) a perfect antenna.

So now we have established why you cannot measure emissions close-up, but we still need to consider what near field probes can and cannot do. There are two types of probe, because as we have seen, there are two types of near field, the electric (E) field and the magnetic (H) field. The magnetic probe takes the form of a small loop antenna which will respond to any magnetic flux coupling through the loop. The electric field probe is in essence a small monopole antenna. They are normally supplied in pairs and can be either passive or active. The active type have a broadband pre-amplifier built into the probe and as a result offer greater sensitivity and smaller tip size, better for accurate probing.

Consider a length of wire, open circuit at one end and being driven by an oscillator at the other. Fig 4 shows the instantaneous current distribution along the wire. At the driven end it will be at a maximum, but at the open circuit end it must be zero. The current distribution looks like one quarter of a sine wave, and indeed this corresponds to the system in resonance. When wire has a length equal to one quarter the wavelength of the driving frequency the current peaks sharply and we have a tuned antenna. If the incoming frequency has components that happen to coincide with this tuned frequency, these components will be radiated.

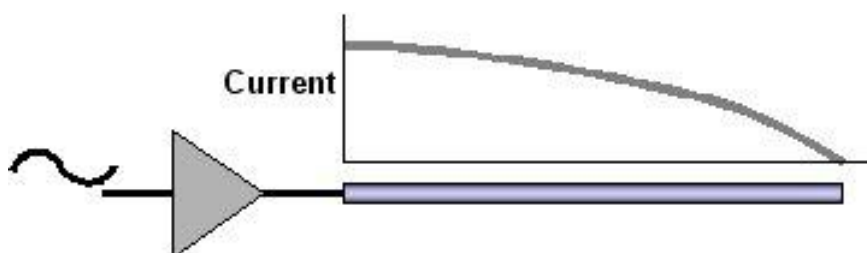

Fig 4. Cable resonance

Fig 5 shows a classic situation. We have our 16MHz clock source and this exhibits a full set of harmonics, gradually reducing in level with frequency. See the top plot. This is what our near field probes will see.

This signal is coupled to a wire that is 60cm long. It has a characteristic as shown in the middle plot. This will be resonant at a wavelength of 2.4m (4 x 60cm) which is 125MHz, so the 8<sup>th</sup> harmonic (128MHz) of the 16MHz source will be strongly radiated, even though this is a relatively small component of the original source. See the lower plot.

In fact, assessing any product in terms of its physical size and the length of any cables connected to it can sometimes give you a feel for what may be problem frequencies. Products fitted with a 1.5m mains lead can be a problem at 50MHz, and a golf trolley with a 50cm cable between the control panel near the handle and the motor at the wheels had an issue at 150MHz.

All this shows that it is the ‘accidental’ antenna that dominates the emission spectrum, and that the near field probes can give quite the wrong impression.

However, all is not lost, the probes do have several useful purposes.

- They can be used as sniffers to detect what frequencies are present in a product. Knowing which frequencies to look for is a great help when measuring emissions on an OATS...
- Once a ‘problem’ is identified, the near field probe can help to track down the source. Active probes are good in this respect as they have high sensitivity and small probe tips.
- Probes can help with relative measurements if used with care and have a ‘proper’ EMC result to act as a reference.. For repeatability, the probes must always be placed in exactly the same position relative to the product during each check.
- They can be used as a QC tool to ensure that products off the ‘production line’ are consistent in terms of EMC characteristics, thus helping to fulfil the the ‘due diligence’ requirements of the EMC Directive to ensure that volume production is regularly monitored.

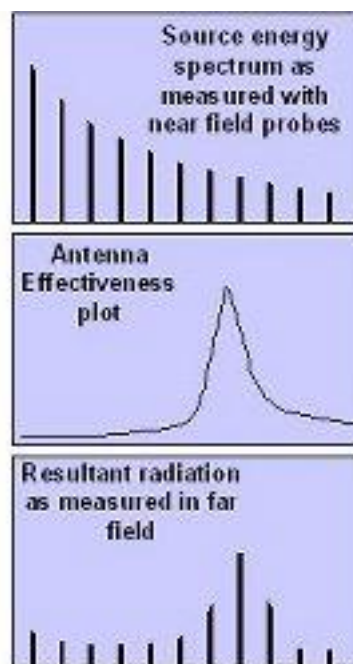

Fig 5  
*Effect of the aerial*

For details of active and passive near field probes, see....

<http://www.laplace.co.uk/product/18/>

<http://www.laplace.co.uk/product/17/>

## Annex 2: Pre selectors... what, why and when?

Most of us working in EMC will have heard comments about pre-selectors. This article sets out to explain what these are, why they may be necessary and when you should use one.

A check with the EMC 'bible' (CISPR16) will show that all radiated and conducted emission levels should be measured with a 'measuring receiver'. Most of us will be using a 'spectrum analyser' or EMC analyser, **not** a measuring receiver! The essential difference between an analyser and a receiver is the 'pre-selector'. This unfortunately tends to be an expensive item, judging by the price differential between analysers and receivers. However, if the bible thinks it is important, perhaps we ought to at least know what it is and why it is apparently necessary.

For many applications, the spectrum analyser is perfectly adequate, provided that it has 'real' QP and average detectors and an adequate dynamic range. However, there are circumstances when a spectrum analyser will give false results. This article will explain how to check for these 'circumstances' and how to avoid them.

All RF spectrum analysers, regardless of manufacturer or type, even the PC software controlled varieties, use the same basic principle of operation. This is shown in fig 1.

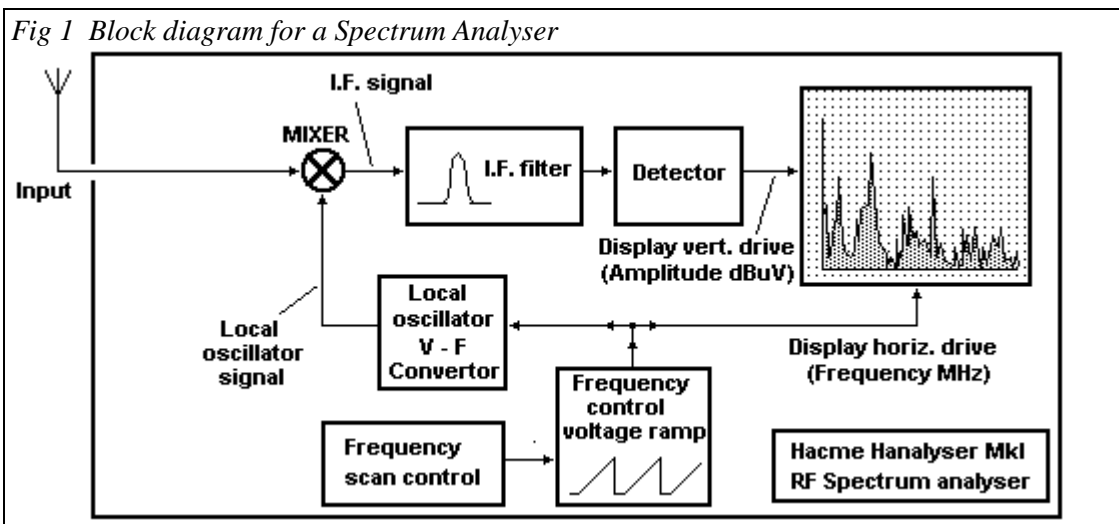

The essential features are the MIXER which mixes the incoming signal with a pure frequency from a local oscillator. The resulting mixer output includes sum and difference frequencies which are filtered to produce a fixed frequency I.F. signal which is detected and fed to the vertical scale on the display.

Note that a real analyser is far more complex, typically using three I.F. stages and complex filtering to eliminate all unwanted mixing products.

The key item in this analysis is this mixer. Note that the incoming signal is effectively fed directly to this device, so it has to cope with all frequencies and has a broadband characteristic. Mixers have only a certain amount of dynamic range. Dynamic range is the difference between the strongest signal we can cope with and the smallest signal we can see. This 'window' can be moved up and down by switching attenuators in or out.

Assume we are testing for radiated emissions on an outdoor site.

The FM broadcast signals may have a strength of 90dBuV/m or more. Our limit levels are of the order of 30 to 40dBuV/m and we need to 'see' that our emissions are significantly below

this level, say down to 20dBuV/m. This implies a dynamic range of at least  $(90 - 20) = 70\text{dB}$  and that assumes the attenuator is set to the optimum level.

Some analysers have mixers that have only 50dB dynamic range...so you can visualise the problem!

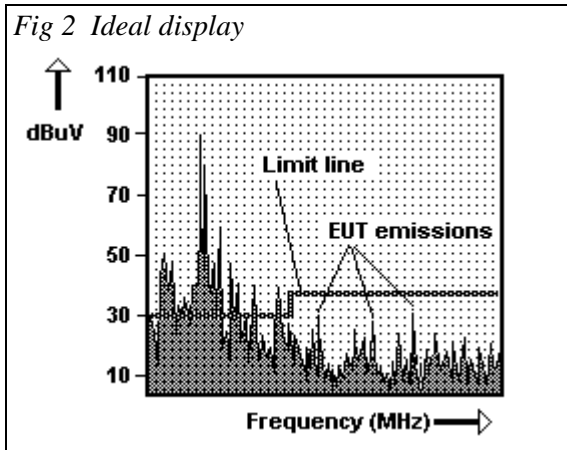

If we have an analyser with 50dB dynamic range, and need to measure the emissions in the above scenario, we could set the attenuators so that the baseline is at 20dB. This should enable the measurement of the EUT emissions anticipated in the 20 - 30dB range. Unfortunately, this now means that the strongest signal we can properly see is 70dB.

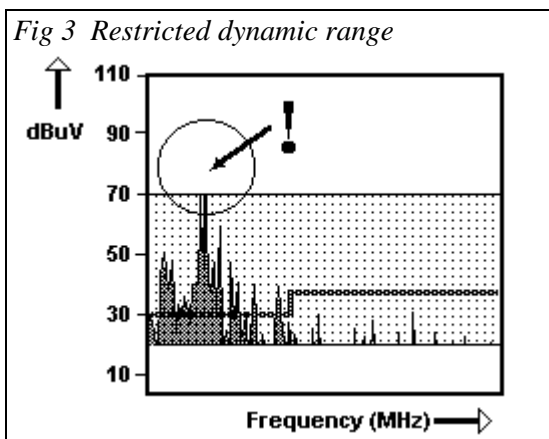

So the strong 90dB components in the spectrum will be 'overloading' the mixer. This is akin to the overloading of an audio amplifier. Although it is not an overload in the sense of causing a catastrophic failure, it is pushing the circuit into a non-linear mode of operation and hence will cause signal distortion. This can be clearly heard on an audio amplifier, but with a spectrum analyser there is no easy way to tell. These 90dB components will be 'compressed' by at least 20dB to fit within the range of the

analyser output. That means that the considerable signal energy apparently lost due to this compression will in fact appear as false indications at other frequencies.

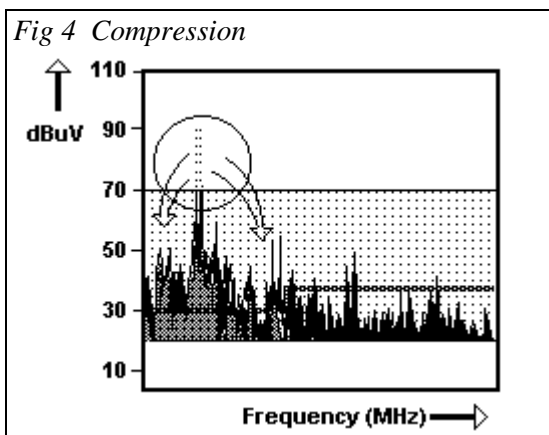

The black areas in the diagram show how this excess energy totally corrupts the real signal spectrum both as false harmonics and other random effects. This distorted result will look perfectly valid. There is no way of telling whether the result is good or is corrupted by 'compression' simply by looking at the screen.

A simple test we can always apply is to increase the attenuator by 10dB. The result should be an identical trace, but moved down by 10dB. If compression was present, the trace not only

move down, but will change because the amount of compression will have been reduced by 10dB. It is good practice to always make this check if in doubt about the input signal level.

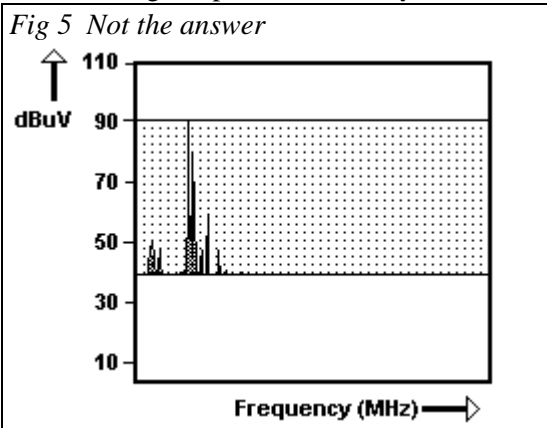

To avoid the problem of compression, the attenuator should be increased so that the strongest signal is within the range of the analyser. This will completely eliminate the problem of compression, but now the results are effectively useless because we cannot see the signals of interest.

Clearly, we need a better answer! This is where the measuring receiver enters the arena. The major difference between the receiver and a spectrum analyser is the addition of a **pre-selector**.

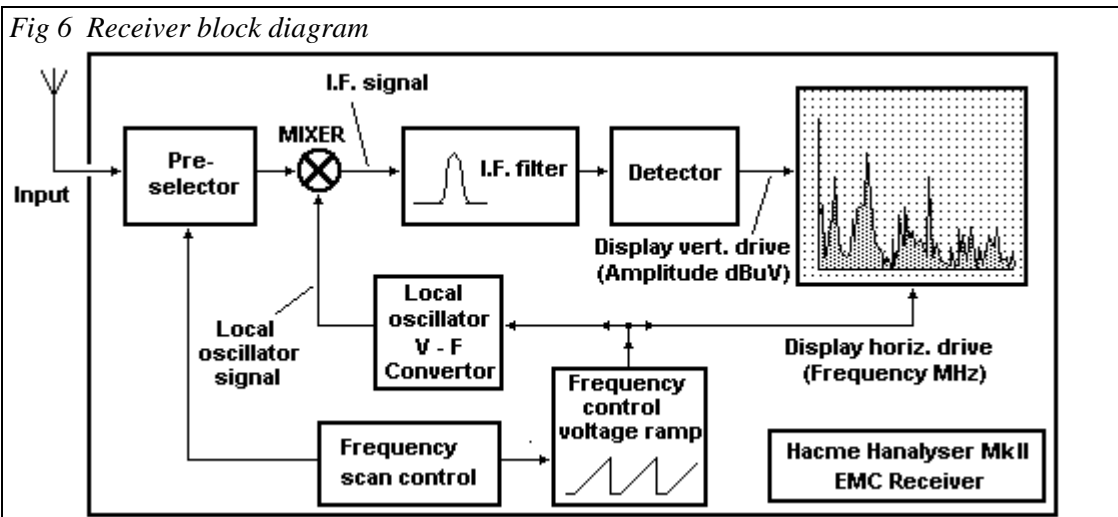

The pre-selector is really a series of bandpass filters which can be switched into use one at a time. The total range of frequencies covered is matched to the frequency range of the analyser. For an EMC band B analyser (150KHz - 30MHz) the pre-selector may have 7 bands to cover this range.

Band No.	Pass band (MHz)	
	Start	Finish
1	0.15	0.3
2	0.3	0.6
3	0.6	1.2
4	1.2	2.5
5	2.5	5.0
6	5.0	12.0
7	12.0	30.0

The Laplace RF900 series pre-selectors has bands split as shown in table 1. These can be automatically switched in one at a time as the analyser is scanning. Operation is transparent to the user.

The effect of the pre-selector is to allow only a narrow band of frequencies through to the mixer. This band includes the frequency currently being swept. As the sweep frequency increases and reaches the end of one band, the pre-selector switches over to the next highest.

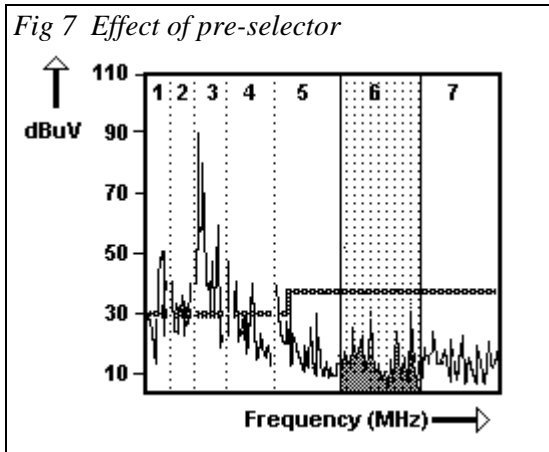

The diagram shows the effect of the pre-selector as the analyser sweeps through band 6. Only band 6 signals are visible to the mixer, all other frequencies having been attenuated by the pre-selector filter. In particular, the high energy signals are removed and the sensitivity of the 'analyser' can be increased by reducing the attenuators so that the low level EUT signals can be properly measured without suffering compression.

Although some of the examples above are related to band C, the radiated emission band above 30MHz, some of the worst signals (from a compression point of view) are experienced in conducted emissions testing. Here the signals from many sources are highly impulsive (eg. Phase angle power controllers, commutator motors etc....) These generate considerable broadband energy (see .....) despite a relatively low average or QP reading at any one frequency. Under these circumstances, pre-selectors are almost essential unless the analyser has exceptional dynamic range (110dB or more).

The Laplace range of pre-selectors feature manually switched and automatic versions. Either of these can be used with any spectrum analyser, providing a vast improvement in effective performance by emulating the action of a receiver.

#### **A real example.**

These plots were acquired with a Laplace SA1000 analyser, standard 16A LISN and RF910 pre-selector. The product was a table lamp fitted with a light dimmer. This dimmer was set at the lowest of two intermediate settings. The first sweep (fig 8) was taken with no pre-selector, the second (fig 9) with the pre-selector in circuit.

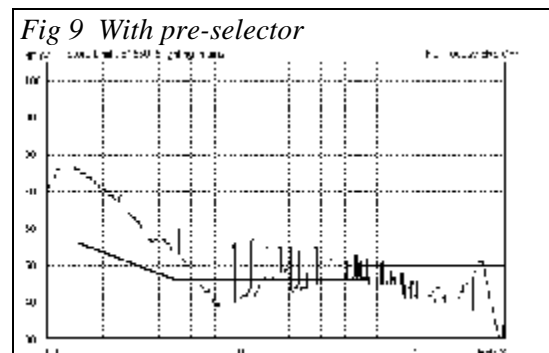
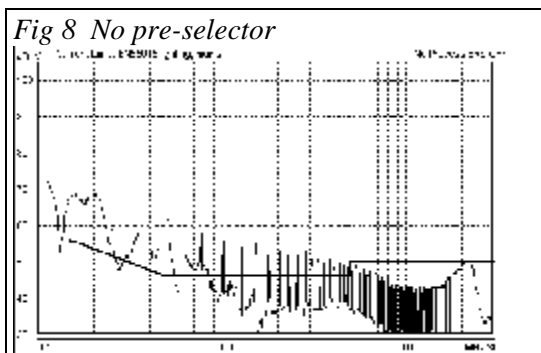

The results are quite different! Note that the 'corruption' of the spectrum has had the effect of generally reducing the measured levels. This is a feature of broadband compression, whereas compression due to narrowband signals (such as used in the example of FM transmissions above) tends to result generally in an increase of levels.

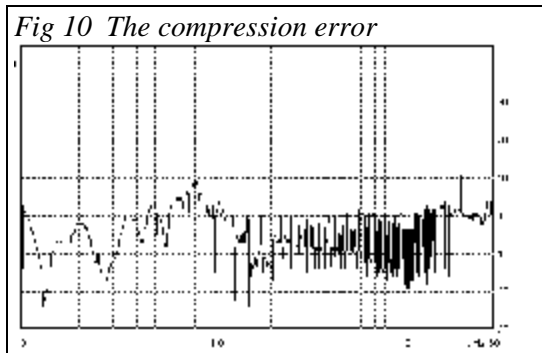

The final diagram Fig 10 is a plot of the difference between the two plots. This clearly shows that errors in excess of 10dB, up to 20dB in places did occur.

Points to note are:

- Compression can affect any spectrum analyser. (I have personally seen it happen with unsuspecting users of the most expensive instruments)
- Many analysers do not warn the user that compression has occurred. Unless you know the signs, the 'compressed' results will look perfectly OK.
- Always check for compression, particularly if the signal is generally broadband in nature.
- The test for compression is to change the attenuator (increase if possible) by a known amount (eg 10dB) and check that the trace is simply shifted by the corresponding amount, but is otherwise identical. If there are other changes, compression is present.
- If you are dealing with signals that are, or may be causing compression, use a pre-selector. Models RF910 and RF915 are available from Laplace Instruments and are compatible with any spectrum analyser.

### Annex 3: EN55022 Upper frequency limit

Recent changes to the Standards that directly affect test requirements and test techniques. (note, this list is not exhaustive. It includes only those items which directly affect EMC emissions test systems as supplied by Laplace).

There are 3 changes of note:

Upper frequency limit in EN55022.....

EN55022:2006 went into effect in the EU on 1<sup>st</sup> October 2009.

One of the items introduced in amendment A1:2007 to this new issue of the standard is an extension of the frequency range to 6GHz. This amendment applies from 1<sup>st</sup> October 2010. After that date, compliance with this requirement is a mandatory part of CE marking.

In detail, the maximum frequency that must be measured for compliance will be:

Maximum internally generated signal (eg clock frequency)	Upper frequency to be measured for CE compliance
Up to 108MHz	1GHz
108 – 500MHz	2GHz
500MHz – 1GHz	5GHz
1GHz +	6GHz

And the limits for the range 1GHz and above are:

Freq. Range	Class B ITE		Class A ITE	
	Peak	Linear average	Peak	Linear average
1 to 6GHz	70	54	76	60

Values are given for measurement distance of 3m. Allowable distances are >1m and <10m. Limit values are adjusted to take account of distance:

$L_{(dist)} = L_{(3m)} + 20\text{Log}(3/d)$  where d is the distance.

Other changes in 55022:2006 relate to the measurement techniques for emissions from telecom ports, specifically the design and use of the ISNs. This is a complex issue, with 4 different test techniques suggested. Perhaps this should be considered 'work-in-progress'. In the meantime, changes to EN55015 (CISPR15), see below, imply that the use of CDNs are a reasonable alternative. The x46 series of CDNs from Laplace are calibrated for emissions measurement up to 400MHz.

It is expected that other countries that have adopted CISPR22 will implement the same changes at the same time, or soon after. These countries include As/NZ, Taiwan, Japan, Hong Kong, Korea, South Africa and Singapore.

## Annex 4: Harmonics and Flicker

This is now a mandatory requirement (as from 2000) for any product that is powered from the mains supply and is rated at under 16A per phase.

The relevant standards are:

Harmonics: IEC61000-3-2 (refers to IEC61000-4-7)

Flicker: IEC61000-3-3 (refers to IEC61000-4-15)

Harmonics relates to the way in which products draw power (current) from the mains. Whilst the mains voltage is a relatively clean sine wave at 50Hz with little in the way of harmonic content to distort the waveshape, products usually draw current in a very non-sinusoidal manner. For example, a standard rectifier/reservoir capacitor power supply circuit only draws current at the voltage maxima, so the current waveform is very non sinusoidal and therefore (by definition) includes high levels of 50Hz harmonics. The power distribution system, and the power generators themselves are designed to create and transfer power very efficiently at 50Hz, but are not designed for the higher harmonic frequencies. This introduces stresses which causes reliability issues in the system. Hence the need to limit the harmonic content of the current drawn by products from the mains. This standard requires the measurement of harmonics up to the 40<sup>th</sup> (2KHz) and imposes limits on each harmonic. Later versions of this standard also includes 'interharmonics' and rules about fluctuating harmonics.

There are 4 'classes' of product:.....

- A. Anything not covered by the classes below.
- B. Hand tools
- C. Luminaires
- D. Computer (PC) equipment and ancillaries

Each class has its individual limits and measurement criteria, so it is important to select the correct class. Class C has the tightest limits, simply because of the quantity of luminaires in use. So even when each one imposes a relatively low level of harmonic content, the large numbers all have an additive effect.

The Flicker standard is related to the way in which heavy loads on the mains tend to slightly reduce the local voltage level, due to the finite impedance in the local distribution system. This slight reduction can have a noticeable effect on the light output of incandescent bulbs. If the load was one which pulsed on/off at 10Hz there would be a corresponding 10Hz flicker in the illumination. This can trigger episodes of epilepsy in those prone to this condition. Hence the need to limit this pulsing of current consumption. The standard covers both this 'Flicker' effect and a direct measure of voltage change. Changes are not allowed to be more than 3.3% repetitively, or 4% maximum. This has implications for inrush current. If the source impedance as specified in the standard is purely resistive and the 4% maximum permitted voltage change is assumed, then the maximum allowed inrush current is 23A.

Flicker is measured by monitoring the load taken by a product and performing some highly complex statistical analysis on the results. There is a short term flicker parameter (*Pst*), which is assessed over a 10 minute period, and a long term parameter (*Plt*) which is assessed over 12 short term periods, ie 120 minutes. For the product to comply, *Pst* must be less than 1 and *Plt* must be less than 0.65.

The best part of the standard is a clause which states that if it is obvious that the product cannot cause flicker, then no testing is required. This clause probably applies to 99.9% of all products because they (a) do not take heavy current and (b) do not pulse the current at between 1 and 20Hz.

**Annex 5: LISN installation**

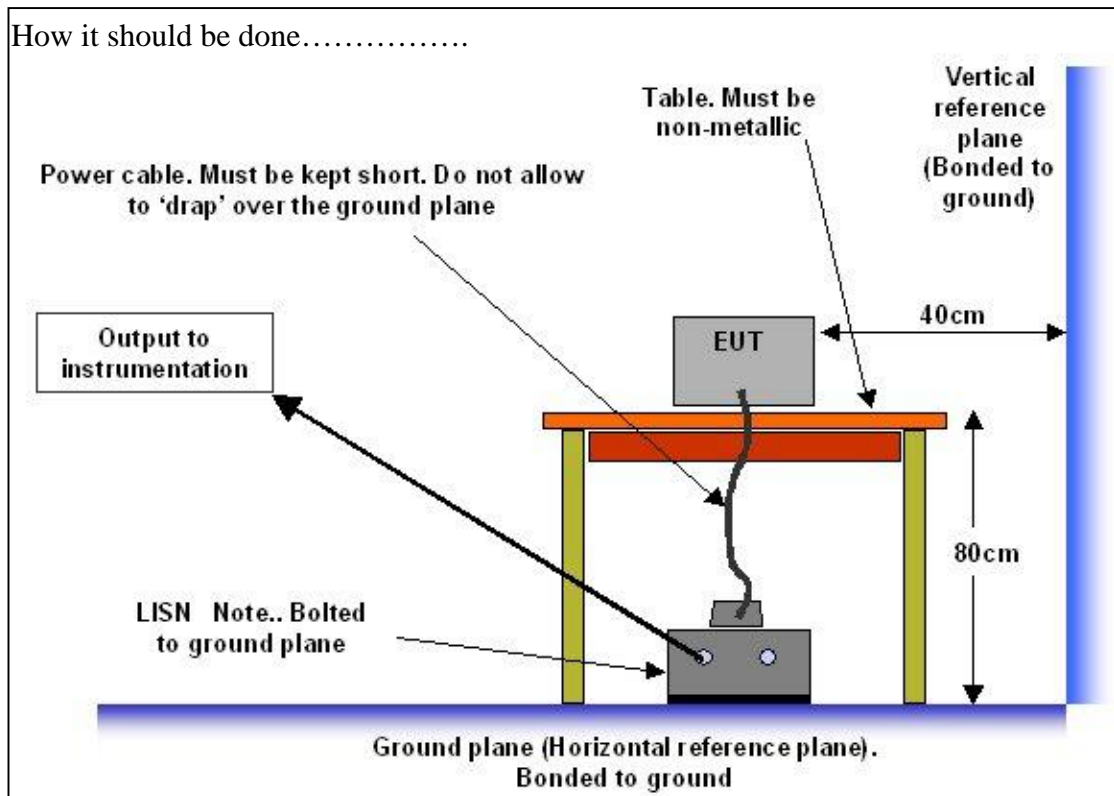
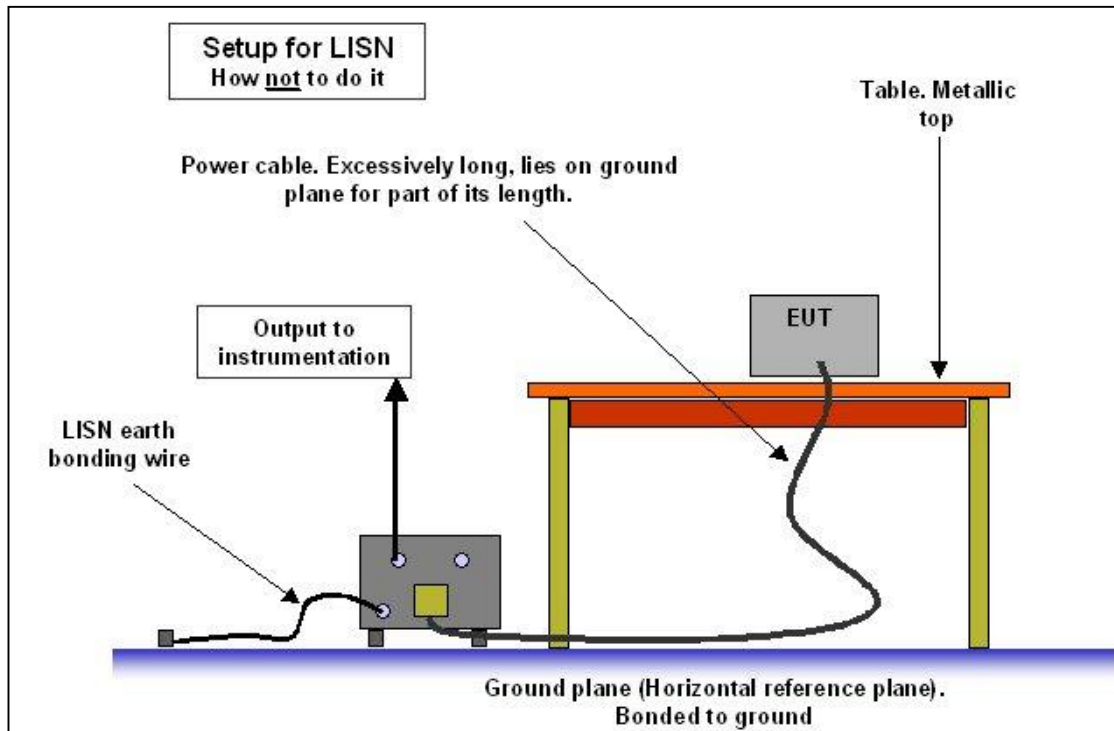

The reasons why the setup are as shown above, and why it matters are shown below...

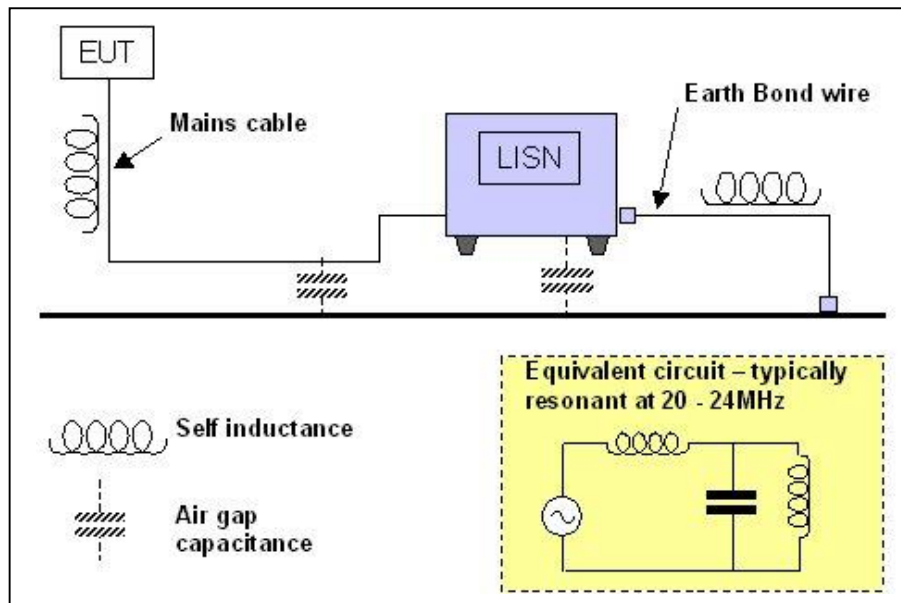

The arrangement above shows how the chassis of the LISN and the ground plane form an airgap capacitor. The purpose of the Earth Bond is to short out this capacitor, but

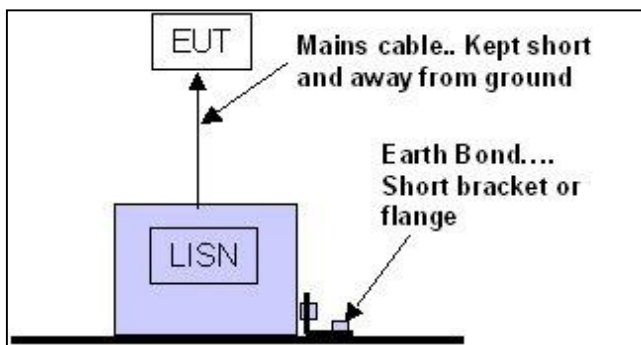

even a short wire at 30MHz will have significant self inductance, thus negating its purpose. To avoid this situation, CISPR16 specifies that LISNs should be bolted direct to the ground plane and that the mains lead to the EUT is kept short and away from the ground plane.

## Annex 6: Detectors

The detector in an EMC analyser or receiver is the part of the system that actually measures the level of the signal after it has been extracted\* from all the other frequency components.

*We could simply connect the output from this detector the input of an ADC and plot the results on the screen. What would we see?*

As the system scans across the required frequency range, we can expect the output to vary in response to the spectrum of the incoming signal. Obviously, we will need to restrict the rate of the scan such that the bandwidth of the ADC and other parts of the system can 'keep up'.

If we stop the scanning for a moment, so we are looking at just one frequency, the output would either be steady state (which would indicate a continuous input signal) or would vary with time (indicating a non-continuous input signal, ie one that included transients or bursts or was modulated). In essence, the above describes how a 'normal' spectrum analyser operates.

EMC receivers (or analysers) are different.

A key issue is the handling of non-continuous signals.

\*This extraction process is effectively a very narrowband filter which blocks all but the wanted frequency. A narrowband filter sounds simple enough, but those who work in this field know that it is actually quite a demanding task to create such a filter which has the required characteristics (bandwidth, shape, out-of-band attenuation etc,...). If you add the requirement to 'scan' such a filter across a wide frequency range, it becomes just plain impossible. So we use superhet techniques, as used in radio receivers to 'do' the scanning for us. This produces an output whose level equals the magnitude of the incoming signal at the selected frequency.

### Detectors

EMC standards specify the use of 3 (possibly soon 4!) different detectors. They all give different answers. They are Peak (Pk), Quasi-Peak (QP), Average (Ave) and, recently proposed, the RMS-average detector. The reason for this new detector is that it gives a better measure of the interference effect on digital communication services.

*The diagrams 1, 2 and 3 show how the Pk, QP and Ave detectors work. Peak is quite self explanatory. There are effectively no time delays in the response, it simply indicates the highest signal level seen during the time the analyser dwells at a frequency. In effect, the detector produces its response virtually instantaneously so the Pk detector can be used for fast scanning. When the result has been acquired, the analyser moves to the next frequency and the detector is reset by discharging the capacitor. (The reset circuitry is not shown in the diagrams).*

Again, the average detector is quite simple. It applies a linear average to the incoming signal.

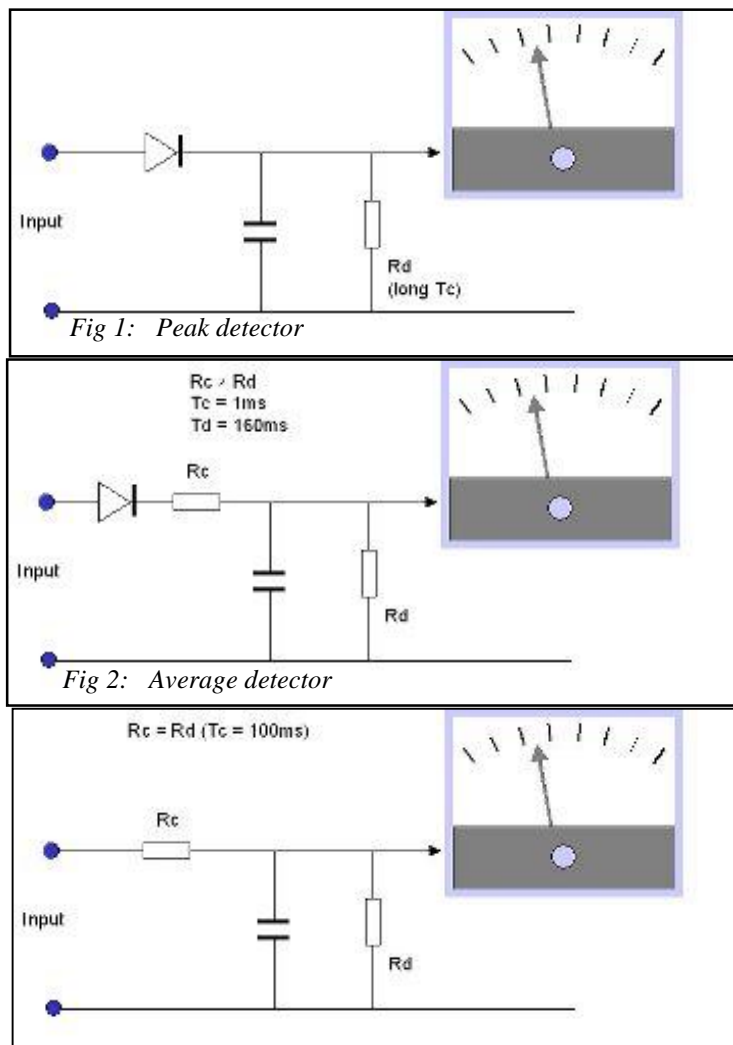

The QP detector includes features of both the above. In particular, note how the time constant for the capacitor charging is short (1ms) compared with the discharge time constant (160ms). To understand why we need these alternative detectors, consider the fact that often, interference is subjective.

### Detector purpose

For example, I have a table lamp which includes a phase angle controlled light dimmer stood next to my audio system. When the lamp is on, I can hear a 100Hz buzz superimposed on my audio output... drives me nuts!

I also have in the kitchen an electric cooker with an old temperature control system that switches power via a contactor which switches every 5 seconds or so when the oven is up to temperature. The transient created by the switching of this contactor is far greater than the transient caused by the phase angle switching of the lamp. If we use a peak detector, the oven controller would produce a result far higher than the lamp, and this is a problem, because it's the lamp that is actually the worse source when considering the subjective consequences of the interference. It may seem that the average detector would overcome this problem given the relatively fast repetition rate of the lamp transients.

Unfortunately, the transients are so short (in both cases) that average detectors simply do not respond and the result for both sources is practically zero. Average detectors are in fact most useful when modulated signals are included in the interference input.

Quasi-peak detectors are simply a design that happens to produce the 'right' results, ie results that approximately correlate with the deleterious effect on broadcast reception and the subjective effect.

### Actual waveforms

Fig 4 shows the response of a real detector. The dark red trace is the input, the blue trace is the peak detector and the green trace is the QP detector. The timebase has been set so that the measurement of one frequency can be seen This is the dwell time and in this particular case it has been set to 400ms.

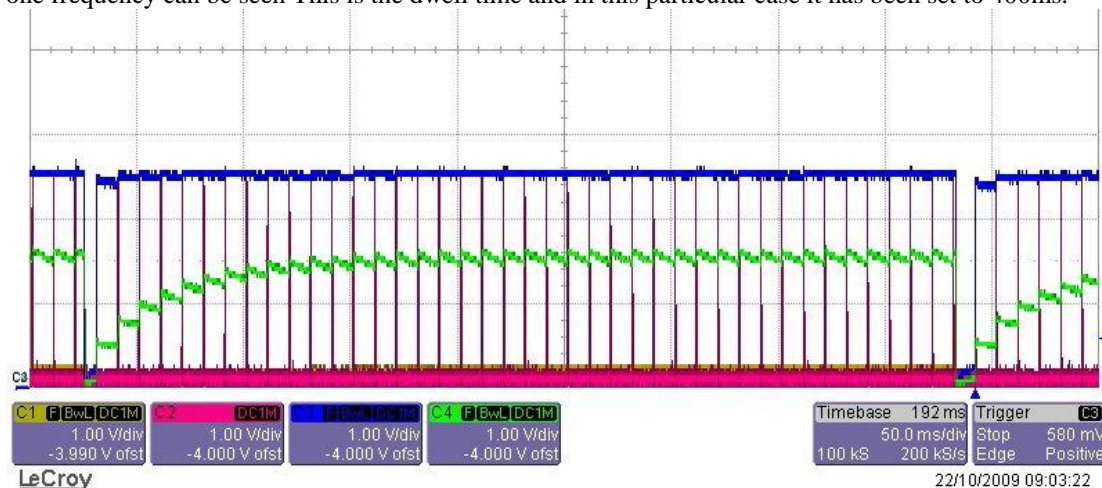

Fig 4. Oscilloscope view of detector output

All detectors are seen to be discharged at the beginning of each dwell time.

The red incoming signal is from the light dimmer and the 'spikes' at a repetition rate of 100Hz are clearly seen. Note how the QP detector is charged up by each spike due to its fast rise time, and between spikes, the slow discharge 'slope' can also be seen. From this image, it becomes obvious why EMC receivers (and analysers) are so slow when taking measurements with the QP detectors. Even with a 100Hz transient repetition rate, the detector takes some 200ms to achieve the 'correct' level. With slower repetition rates, the detector takes corresponding longer. CISPR16 specifies a 1 second dwell time for band B. Band B (150KHz – 30MHz) has an RBW of 9KHz and so the frequency step must be equal to or less than 9KHz. This means that there are at least  $(30,000-150)/9$  results to be taken in this band. From this a scan time of 55 minutes can be deduced.

Figure 5 shows a similar situation, but this time the signal comprises the broadband 100Hz transients plus a narrowband component. When the analyser is at the frequency of this narrowband component the detector output has a mostly continuous nature. The figure shows this as the middle dwell period and the average detector (yellow trace) is clearly seen, rising to match the levels of the peak and QP detector levels.. Again note the time scale for the rise time. The QP detector shows a fast rise time (as

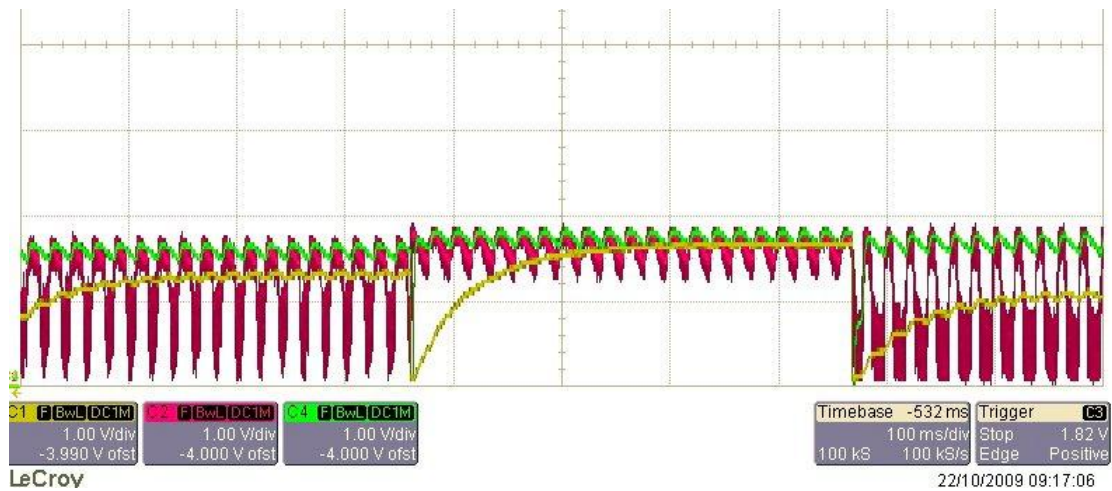

Fig 5: Detector response for steady state signal.

expected) and the average detector a relatively slow rise time. The measurements either side of this frequency peak show what happens as the continuous signal ‘degenerates’ towards the impulsive 100Hz signal with consequent drop in the average result.

**Scan time**

The Laplace analysers actually sample the frequency every 0.6 x RBW and this is a fairly common practice, so the 55 minutes estimate (see above) becomes 92 minutes. Clearly it would be a great advantage if this process could be speeded up. We can ‘adjust’ the dwell time, reduce it from 1 second to (say) 100ms, at which time the results are within 10% of the final value for a 100Hz repetition rate. Obviously, if the repetition rate was slower than 100Hz, this error would increase, so reducing the dwell period is not recommended unless you know the characteristics of the signal. In order to speed up the test process however, standard practice at test labs and all those experienced in the art of EMC is to initially scan with the Pk detector. Because the Pk detector will always produce the highest result (compared with the QP and Ave detectors) it will be obvious that if this Pk result was below the limits, then the EUT is compliant. In this case no further testing is required.

Only if the Pk detector exceeds a limit will measurement with the other detectors be necessary. In many cases, the limits are exceeded only at certain discrete frequencies. Some analysers are fitted with markers which can be ‘dropped’ onto these problem frequencies and which will then display the Pk, QP and Ave levels at these points. These will enable fast and accurate monitoring of these problem

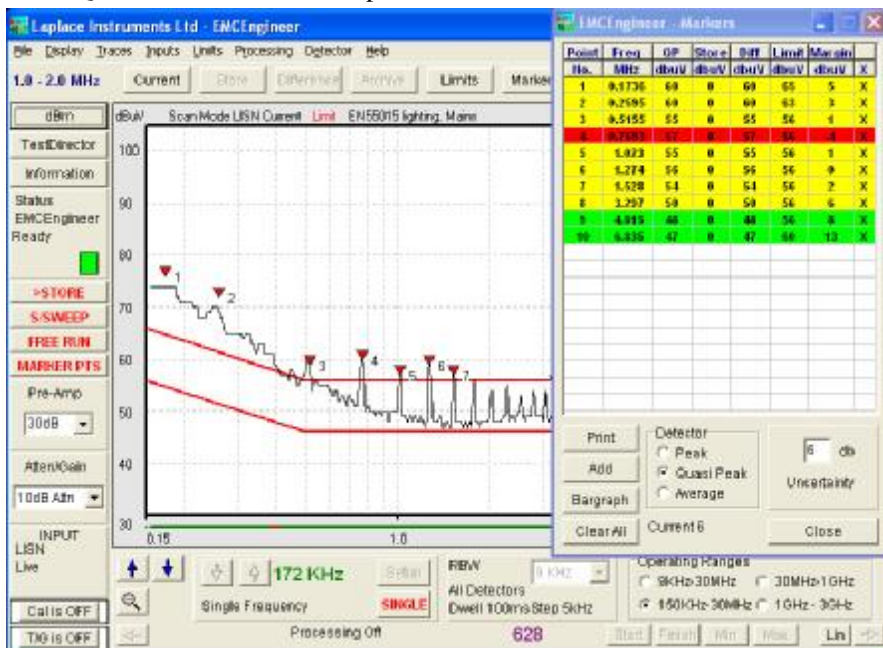

Fig 6. Marker display

frequencies, virtually in real time, enabling troubleshooting and modifications to be observed immediately. Fig 6 shows a screenshot taken from a Laplace EMC analyser with the Pk detector plot displayed and a tabular list of the measurements at the marked frequencies. These are currently showing the QP values.

For convenience, an alternative view is the bargraph plot, shown here (Fig 7) which shows immediately how the results compare with the limits. The centre line is normalised to the limit level and results are plotted  $\pm 20$ dB, with the uncertainty margin clearly shown. The buttons on the RHS allow the different detectors to be selected and displayed. Difference plots can also be shown.

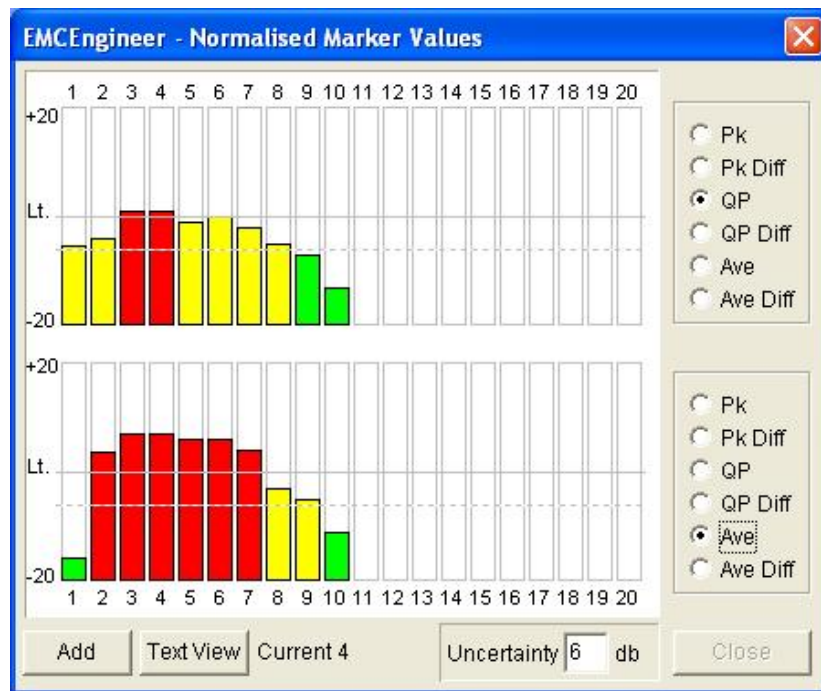

Fig 7. bargraph presentation

*There are proposals to allow the use of the RMS-*

*Average detector as an alternative to the QP and Ave detectors with just the one limit level (which would be 4dB above the current Ave level, hence 6dB below the QP level). Where only the QP limit is applied to a band, the QP limit would be retained. The advantages are that only one detector is used for the entire frequency range (9KHz – 18GHz) and that this detector has a faster response time than the QP or Ave detectors.*

## Conclusion

True EMC measurements do require the use of specialised detectors, and these involve significant time constants which result in slow scan rates. Faster scanning leads to increased likelihood of error and would be non-compliant. However, techniques do exist which can provide significantly faster results without loss of accuracy, and which can provide key measurements in real time displayed in a form which allows easy interpretation of compliance status.

## **Annex 7: Additional requirements for EN55015**

As from May 2010, EN55015 amendment A1 becomes mandatory. This amendment (amongst other things) introduces clause 4.4.2 which requires measurement of radiated emissions in the range 30MHz – 300MHz.

Groans all round!

The required measurement technique normally used for this band is described in EN55022, and involves open area test sites (OATS), specialised antennas and problems with ambient signals and test site calibration. This test is notoriously prone to high measurement uncertainties unless there is significant investment in resources and facilities.

However, the standards committee have in this case, taken an enlightened and pragmatic view and have specified an alternative technique which is quite straightforward, quick and involves relatively low cost. (That makes a change!)

This is described in Annex B of EN55015:2006. It specifies a technique similar to that used below 30MHz for conducted emissions. Below 30MHz a device known as a LISN is introduced into the mains power feed to the luminaire. This is a well known and established technique that has been used ever since EMC was invented. The new Annex B specifies the use of a CDN instead of a LISN, but otherwise the technique is very similar. [CDN stands for Coupling-Decoupling Network].

Therefore, those who are familiar with the ‘old’ standard, and have the relevant EMC analyser and facilities, can very easily add the capability to accommodate the new standard simply by adding the CDN(s).

CDNs were originally designed for use as RF injection devices, to couple RF onto cables to test the immunity of products to conducted RF interference. This makes them useful, dual purpose items. CDNs come in several varieties. Each ‘variety’ is designed for a specific type of cable. So for a mains cable, a type M2 (L, N) or M3 (L, N, E) is required.

Laplace manufactures a wide range of CDNs for these applications. The unique feature of these CDNs is that they are ‘Versatile’. That is, each model can be ‘programmed’ to suit several different cable types. For example, the S46M3 type is suitable for M1, M2 and M3 cables. This reduces the number of CDNs required to handle a range of different products. Note that during these measurements, all cables to the product should be fitted with a CDN. This means that if (for example) a product has a mains feed, a separate feed from a battery and a third feed for a control bus, 3 CDNs are required, all fitted during the test.

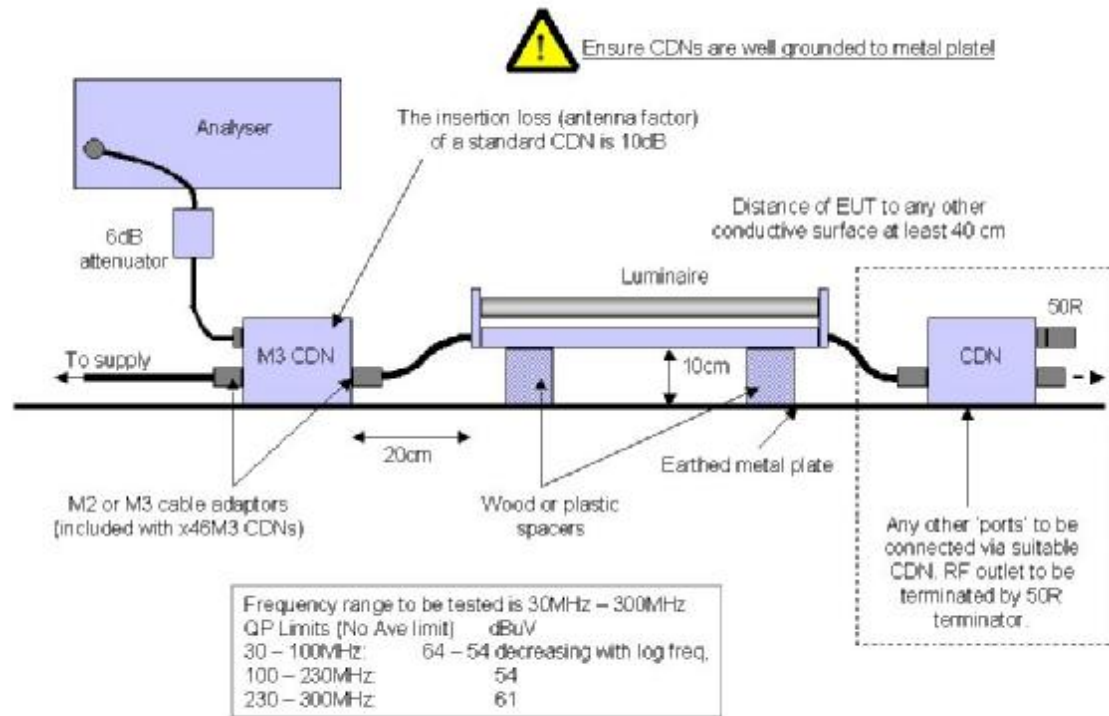

EN55015 clause 4.4.2 Emission measurements – CDN method – Annex B

## Annex: 8: Ambient cancellation... reality or fiction?

The issue of the effectiveness of ambient (background) noise cancellation has been long debated. However, there seems to be little published evidence to justify the claims made by either side of the debate. In the absence of a screened room, test cell or chamber, we have to work in a very noisy environment, so any technique that can help would be welcome. The problem could be likened to trying to listen to the guy with the triangle at the back of the orchestra when all the other instruments are playing at full volume!

The original study was done some years ago, but the work is now updated and is published again as it covers a topic of key importance to the self testing community.

This paper is the result of some simple experiments that were performed by the author in an attempt to provide a clear answer to the question 'Does ambient cancellation work?'. The conclusions were (at least to me) unexpected and surprisingly clear cut!

There are two situations in which cancellation may be used....., identification and measurement. Identification techniques are used to simply locate EUT emission frequencies and/or source locations in the presence of high ambients. In both cases the use of near field probes provides a very effective answer. Those who have attempted to locate emissions reliably in the far field without some kind of ambient cancellation will know how frustrating this can be.

Measurement techniques go one step further and are able (potentially) to measure the EUT emission levels with some degree of accuracy.

This paper addresses this second, more demanding requirement.

Two approaches to the problem of ambient cancellation are currently on offer from EMC test equipment manufacturers.....

1. To measure just the ambient first, then to take a second measurement with the EUT switched on and use software to subtract the first from the second measurement (difference technique).
2. To use a twin channel analyser that can either:
  - a. correlate a near field probe input with the far field antenna input. The assumption being that any significant emission must be detectable in the EUT near field and that near field probes are 'blind' to ambient signals.
  - b. use two far field antennas, one at a significant distance from the test site, and use difference techniques to extract the EUT emissions.

Each technique has its pros and cons. None are perfect! For instance technique 1 suffers in the presence of fluctuating ambient (and ambients **always** fluctuate to some extent) but has the advantage of potentially being accessible to any standard EMC receiver or analyser. Both options 2 require the use of a specialist twin channel EMC analyser and 2(a) exposes as false the assumption that near field probes are immune to ambient. In reality, strong ambients are induced into any cabling associated with the EUT and re-radiated as a near field signal. Both 1 and 2(b) depend on the validity of the 'difference' technique, and it is this technique which is the subject of this paper. The validity of using some kind of 'difference' trace to calculate the emission levels from an EUT in the presence of ambient is based on the assumption that the field strength will increase when a second source with a frequency very close

is switched on. This seems obvious, and is confirmed by the behaviour of OATS sites. It is well known that the ground-reflected signal combines with the direct signal on a standard site to increase the field strength by almost 6dB, which on a linear scale is a x2 factor. Reasonable enough, given that the two signals will be of similar strength. Of course, the signals in this case are strictly coherent (from the same source) and are in phase. Changing the phase relationship (for instance, by varying the height of the antenna) will completely 'undo' this happy result. So phase matters. But does it matter when we are considering an EUT emission with an ambient signal?

This is one of the aspects for investigation in the following experiments.

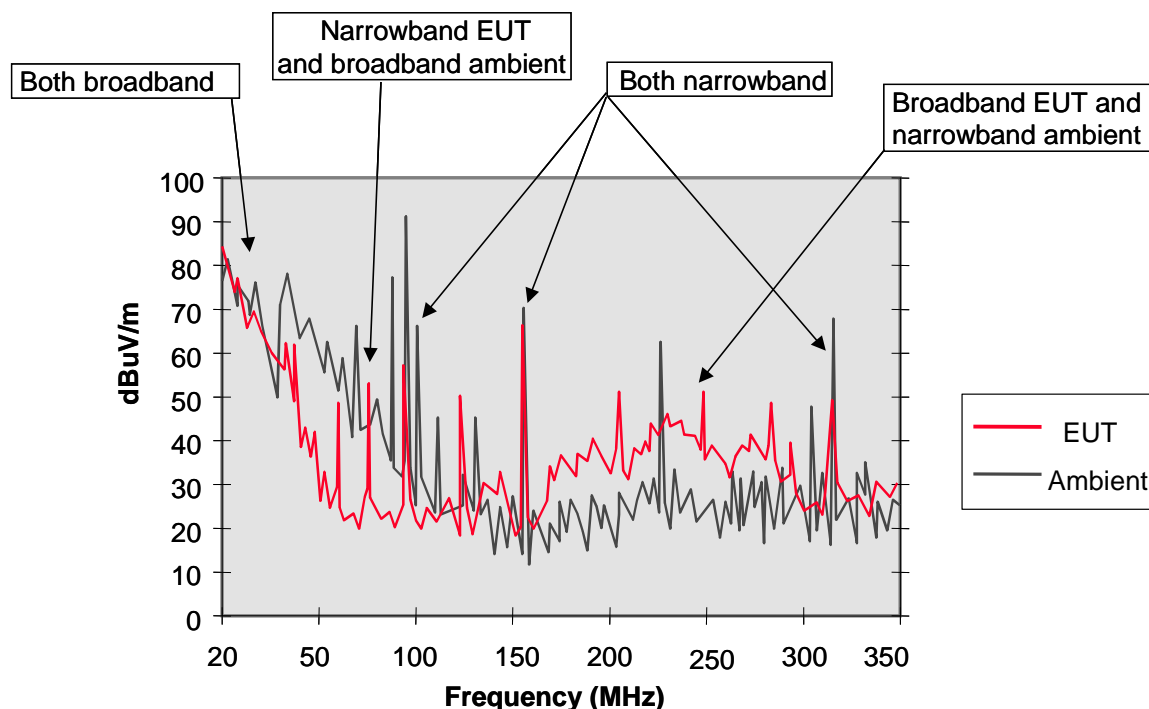

Fig 1. Typical situation. A mix of broadband and narrowband signals.

### Identify the main issues.

Signal types, broadband and/or narrowband?

Signals of both types are common, both from EUTs and in the ambient. We should not assume that any cancellation technique will work equally well (or badly) for all combinations of these two signal types.

It seems sensible to break down the problem into manageable sectors. One way to achieve this is to consider the four combinations of narrowband and broadband signals.

The easy situations... Where the ambient is broadband and the EUT is narrowband, use of the QP detector will usually result in suppression of the broadband signal, leaving the EUT narrowband signal dominant, therefore easy to measure. This is because broadband signals are by definition, impulsive, and will therefore often be attenuated by the QP detector. Narrowband signals are generally continuous and are therefore not reduced by this detector. Similarly, if the EUT is broadband and the ambient is narrowband, it is obvious that by looking at the EUT broadband level either side of the ambient peak, the level is easily measured.

These two situations described above are therefore not included in the following work. Instead we concentrate on the narrowband/narrowband and the broadband/broadband situations as being potentially 'difficult'.

Table 1 shows the potential combinations.

Possible combinations	Narrowband ambient	Broadband ambient
Narrowband from EUT	If frequency separation $< IF$ B/W then peaks merge together. Phase issues may add complications. Possible 'worst case' scenario.	Choice of detector can suppress broadband but leave narrowband (continuous) signals unaffected.
Broadband from EUT	Broadband emissions clearly observable either side of narrowband ambient. By definition, broadband emissions have relatively flat characteristic.	Another potentially 'worst case' scenario.

## The Method

It seems from the above that the toughest challenge for any cancellation techniques is when both EUT and ambient signals are of the same type of signal. Therefore our experiments modelled these two situations.

We created a known 'ambient' and a known 'EUT' signal and studied how the field strength as measured by an EMC analyser was affected when both were on together. The type of signals to create were in line with the above analysis, ie two narrowband sources and two broadband sources.

## The narrowband experiment

The test involved the use of two emissions reference sources (ERS) from Laplace Instruments Ltd, one to simulate the background (ambient) level, the other to simulate an EUT. These are 'comb' generators, essentially narrowband sources with a continuous (in time domain) emission output. They radiate a signal with 2MHz spacing and the two units have a very close frequency matching (actually within 40ppm), well within the resolution bandwidth of the analyser. Thus presenting an almost 'worst case' scenario. The close frequency matching prevents the use of frequency discrimination to separate the signals and the steady state nature of both prevents the use of averaging techniques.

The ERS units actually give very similar radiated output levels, but they were located in different positions in the test site (the laboratory) so that the signals received at the measurement antenna were different from each. The difference is due to the change in 'site attenuation' at the two locations.

The frequency range 350 - 450MHz was chosen as this range was relatively free of other background signals. (note that this test was done before Tetra arrived!).

Each ERS was initially measured separately. The one which gave the lowest levels (as measured by the antenna) was chosen to represent the EUT. This we called unit A. The other (unit B) then represented the ambient.

A sequence was then followed to represent an real EMC test....

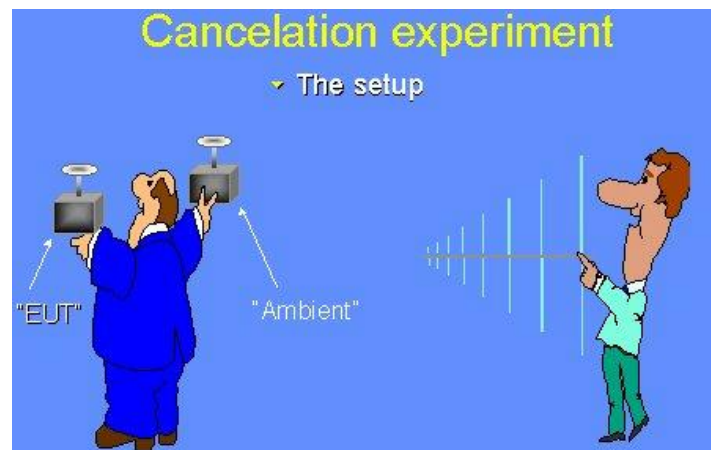
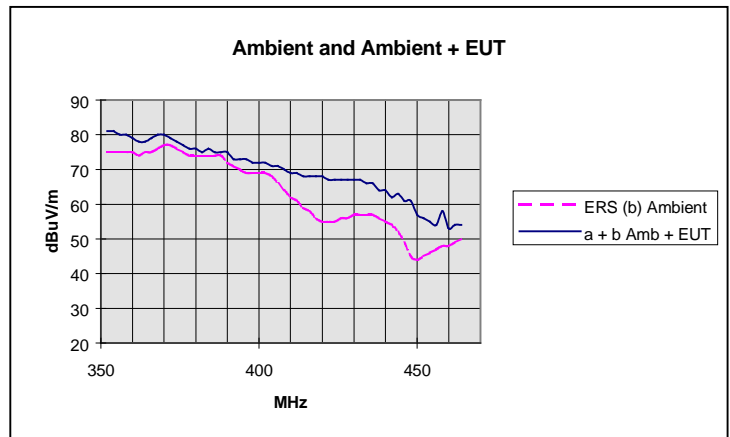
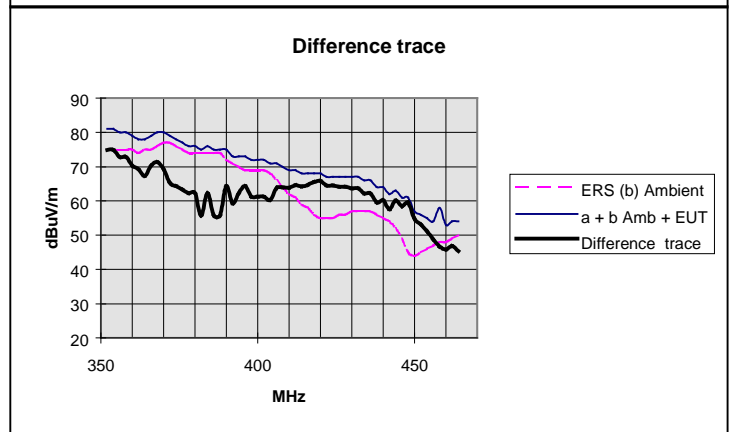

Fig 2. Test configuration

The first plot shows the ‘ambient only’ (unit B) spectrum and the increased level when the EUT is switched on, (units A and B)  
 Note that for clarity, we have plotted the level of only the 2MHz peaks, and omitted the intervening background.



The second plot shows the calculated difference trace  
 Note that this is NOT the simple difference (A-B) but one that takes the log scaling into account (see below).  
 This is the estimated level of the emissions from the EUT.



The third plot is a comparison of the estimated level and the actual level of emissions from the EUT.  
 As can be seen, the difference technique has delivered a remarkably good measurement of the actual emission level.

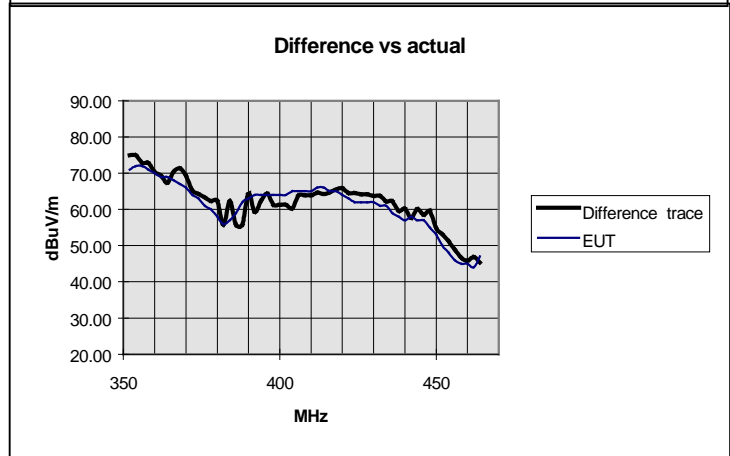

**The Difference trace technique - effectiveness**

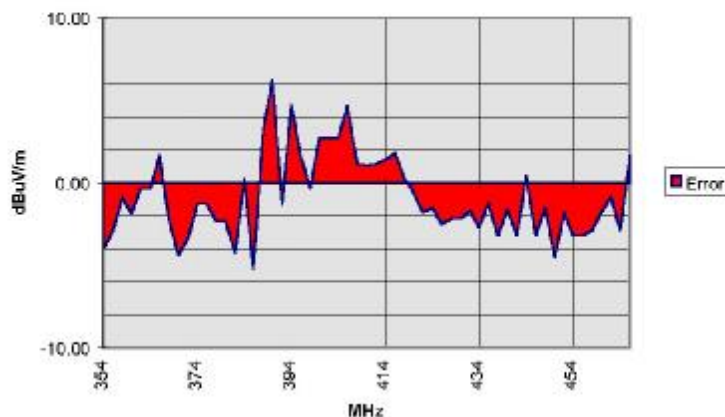

The fact that at 380MHz, the difference trace is within 4dB of the actual even though the EUT is over 15dB below the ambient level, shows that this technique can be remarkably effective.

### The difference calculation

To calculate the signal which caused the field to rise from level  $X$  dBuV/m to level  $Y$  dBuV/m we cannot simply subtract the two numbers to find the difference. Subtracting two log values is the equivalent of dividing one by the other. So these values must be converted back to linear values first using the formula  $X(\text{lin}) = 10^{(X(\text{log})/20)}$  and similarly for  $Y$ . Then the difference  $Z(\text{lin}) = X(\text{lin}) - Y(\text{lin})$ . Finally,  $Z(\text{lin})$  is converted back to log (dB) values.  $Z(\text{dBuV/m}) = 20\log(Z(\text{lin}))$ .

### Phase

This experiment has used two independent sources, hence the signals are incoherent. Incoherent signals are not phase locked. This will be the reality when dealing with EMC applications when an ambient signal is to be 'cancelled'. There will be a phase relationship between the EUT and each ambient source, causing the combined field to fluctuate in level at the difference frequency. So for example, a 253,456,789Hz ambient and a 253,456,800Hz EUT signal will mix to create a resultant that fluctuates at 21Hz. When using a QP detector with a band C time constant of 550msec, it is obvious that these fluctuations will not affect the resultant. Indeed, for any phase effect to be observed, the two frequencies will need to be totally stable to within a couple of Hz, (within 0.001ppm). Possible, but highly unlikely, especially over any meaningful period of time.

### Ambient variation

The only problem that would affect the results is that of an unstable ambient. A technique has been routinely used by the author and others is to stabilise the ambient by using an averaging technique when acquiring both the ambient result and the ambient+EUT result. This is not the same as using an 'Average' detector. It involves repeated scans and then at each frequency, calculating the average level across all the scans. Typically, using this technique on a set of 8

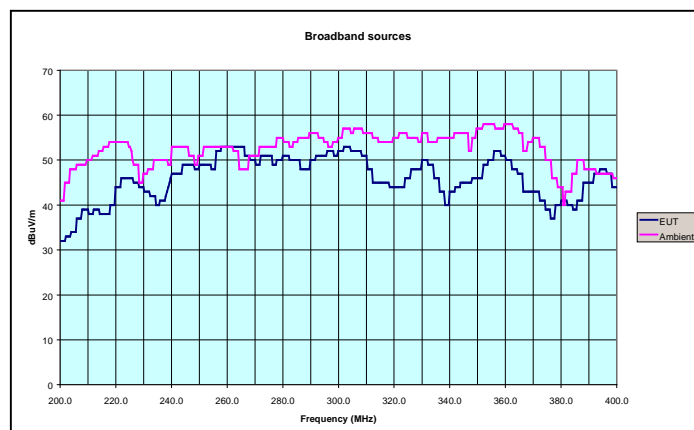

Fig 3 ERS (left) and CNE

scans produces a stable result. The difference trace then produces a relatively 'clean' measure of the emissions from the EUT. Naturally, there is often some rogue transmission that is timed so as to appear as an EUT emission, but simple 'common sense' investigations soon identify these as not originating from the EUT.

### The Broadband experiment

The above procedure was repeated, but this time using two broadband sources, the York



Electromagnetics CNE (Comparison Noise Emitters). These produce a relatively flat output spectrum with high bandwidth impulsive noise sources.

Again the emissions from each were plotted separately at first.

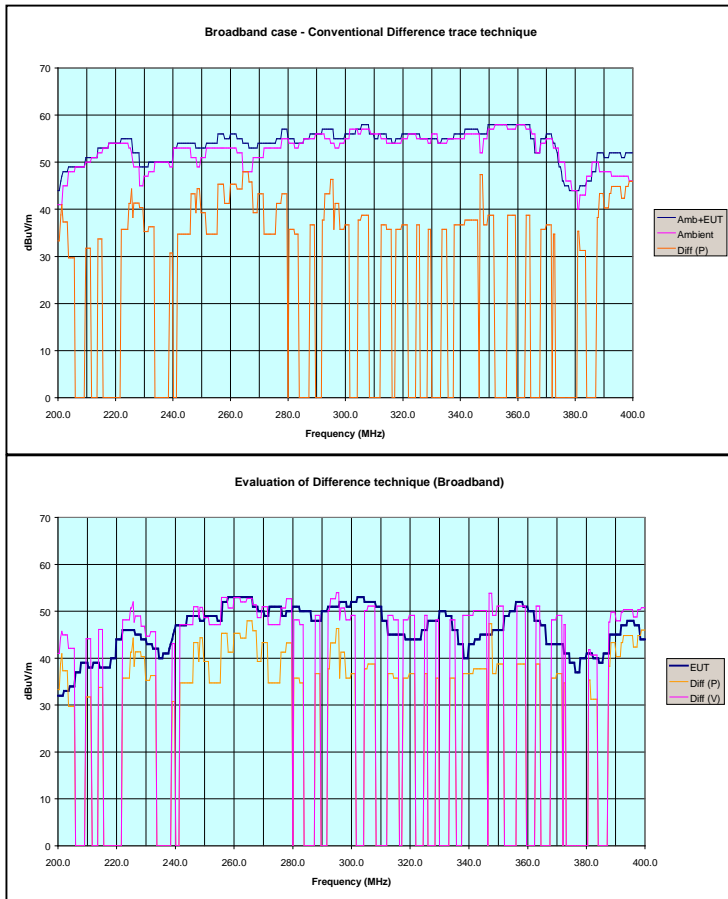

Then plots were taken with first one then both sources switched on. The plot shows the results. The difference trace includes intermittent excursions to minus infinity where the calculation attempts to find the log of zero! The cause of this little difficulty is at frequencies where the ambient result and the ambient + EUT result are the same (or negative).

The final plot shows the actual EUT level (orange trace) and the difference trace as calculated for the narrowband experiment. The results show that the technique has failed to provide even a rough estimate of the levels from the EUT. Clearly the signals were not interacting together in the same way as the narrowband sources. In an attempt to

improve the result, the difference was recalculated using a voltage base (V) rather than a power base (V<sup>2</sup>). The magenta trace shows that whilst it is better, there are still wide inconsistencies.

Use of the QP and Average detectors did not significantly improve matters. In an attempt to resolve why the two signals apparently did not 'sum' together, the signals from the receiving antenna were plotted in the time domain. The following 4 plots are all acquired on a fast digitising DSO (500MHz sampling rate). The time axis is in nanoseconds and the vertical scale is identical for all these plots.

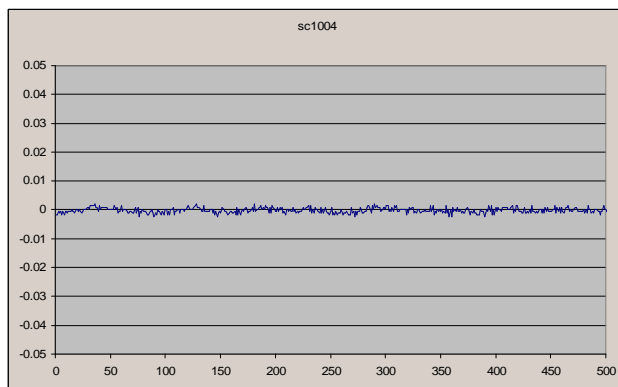

with no sources switched on.

Plot sc1004 shows the ambient as output from the log periodic antenna

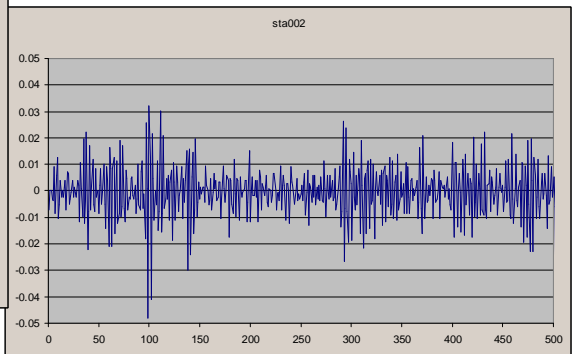

Plots sta002 and stb000 show the signal from the antenna with each source switched on independently. The impulsive nature of these sources is immediately evident. Fourier analysis

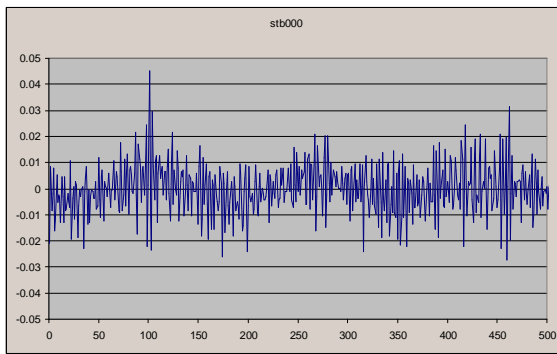

shows that for a flat (ish) spectrum in the frequency domain, the time domain must have a transient nature. The signals are completely random in nature, as expected from noise sources.

Plot sc1000 shows the two sources radiating simultaneously. The frequency of the impulsive spikes has increased, in fact doubled, but the peak levels are unaffected.

Thus a peak detector will generally maintain the same level as the strongest source, unaffected by the presence of any source with a lower level of impulsive peaks. This assumes that the spectral bands of the two sources overlap. If this was not the case, identification of the EUT emissions would be simple!

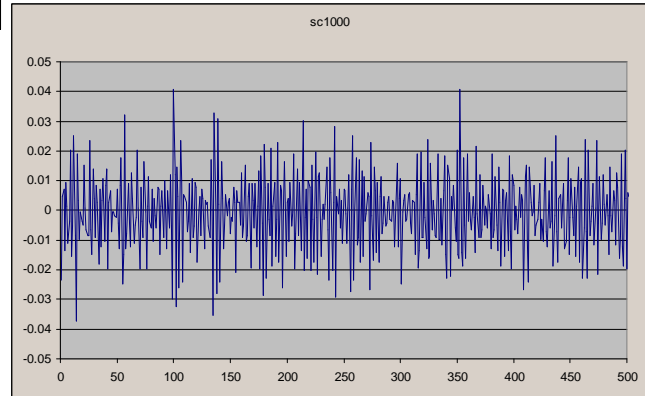

A calculation to show the level of signal in each waveform was undertaken by summing the absolute values of all the DSO samples in each frame.

Ambient only	0.3696V
Source 1	3.7744V
Source 2	3.6467V
Both sources together	5.1472V

This shows that there is the expected increase in signal in the time domain.

It was thought initially that the use of an average or QP detector would improve the performance of the difference technique. This was not observed. Further thought regarding the average and QP detectors as specified by CISPR16 shows why. The output from these detectors is critically dependant on the repetition rate of the incoming impulses. Time constants within these detectors are such that for repetition rates above 10KHz, the detector output will be equal to that of a peak detector. In other words, once above 10KHz, increasing the repetition rate will have no effect. A study of the waveforms shows that significant impulses occur at a median interval of approximately 300nS, equivalent to a repetition rate of 3.3MHz. Well above 10KHz!

Clearly, the above analysis holds true for the noise sources we used (the CNEs). Other noise sources with different characteristics may behave differently. For instance, many sources in the 'real world' are caused by mains frequency switching devices (such as phase angle controllers). These have an impulse repetition rate of 100Hz (or 120Hz). Doubling the rate by introducing a second source would increase the QP level by some 3dB and the average level by approximately 6dB. This suggests that a difference technique would work, but factors such as relative timing (ie relative phase angles) and duty cycle may influence the results.

### Coping with the real world.

Overall, this experiment has shown that in real world situations where both the background and the EUT emissions are broadband with overlapping spectra, and the nature of the noise sources is unknown, (this must be particularly true of the background), the use of any

difference technique should be avoided where possible. In practice however, a modified difference trace technique has been successful in detecting the general spectrum of broadband emissions from an EUT, even in situations of high level ambient. This modified technique involves the use of an average scanning technique coupled with a peak detector.

1. With the EUT off, free run the analyser and invoke trace averaging to provide the average level at each frequency point over the several sweeps.
2. When the resultant has stabilised, cease scanning and store this as the background trace.
3. Switch the EUT on and repeat the average scanning process until the resultant has stabilised.
4. Plot the difference between the two results.

Although not recommended for accurate measurements, this technique does seem to give an excellent estimation of the EUT emissions for pre-compliance purposes.

### **Summary**

Where the ambient and EUT sources are of different signal types (narrowband and broadband) the measurement of EUT emissions is generally possible with common sense judgement.

The difference trace technique works well in the narrowband /narrowband situation, provided that the background is stable. However, additional techniques are available (ie averaging of scans) that have proved very effective in coping with unstable backgrounds.

When both ambient and EUT emissions are broadband, measurements become less reliable and the difference technique may fail even to provide an approximation of EUT levels. However, the nature of the sources used in the experiment may not be typical of the real world. Experience has consistently shown that the difference trace technique does provide a useful guide for EUT emissions even in worst case situations. This is probably due to the lower repetition rates (100s of Hz) that are typically causing the 'real' broadband emissions. In addition, experience shows that emissions from EUTs are usually (but not exclusively) narrowband in character above 30MHz.

In practice, measurement of EUT emissions in the presence of ambient has proved to be very effective. The combination of trace averaging, difference trace processing and test technique has consistently provided results that are within 8 dB of test lab results.

## Annex: 9: Emission Reference Sources

The ERS is a source of precisely known emissions, very stable and completely defined. It is calibrated according to 'best practice' and traceable to NPL.

### When would I use one?

If you are measuring radiated emissions from any product (EUT) for compliance or pre-compliance purposes, then the ERS becomes a valuable asset.

### Why do I need one?

Most EMC standards that relate to radiated emissions specify an OATS as the test site in which to measure these emissions. (OATS = Open Area Test Site). This is because RF signals will reflect off any metallic surfaces and will be affected by many other types of material. Just walk round a test area and see how the human body affects the results! In particular, any metal in the vicinity of the test area can affect the way in which the site behaves. So the only way to ensure repeatability of measurements, independently of test site location, is to use an area free of anything that can affect RF propagation.

If you have such a site.. wonderful, and if it is calibrated...even better. Obviously, all test labs will have such sites, but manufacturers and others simply will not have the resources, or the space, or the budget to afford such a facility.

The standards specify limits, and these limits assume that the EUT emissions are measured as per the standard, ie are measured on an OATS. If the space that you are using is not an OATS, then one thing you can be sure of is that the measurements you take will not agree with those obtained on a true OATS.

### What is the extent of the problem?

The key issue is reflections. To understand what actually happens, take a simple case. Even on the very best OATS, the ground is usually present (if not, we may have a long way to fall!). The ground will reflect RF. The amount that is reflected depends on the reflection coefficient of the ground, which varies according to the nature of the ground, and may vary with climate and local weather conditions. This means that there will always be at least 2 signals arriving at the antenna, that which has travelled the 'direct' route and that which has travelled the 'scenic' route, via the ground.

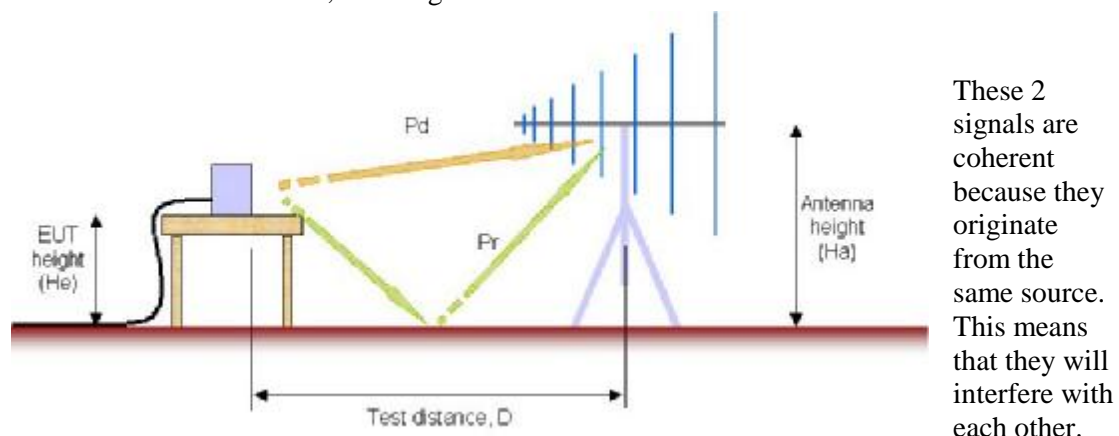

The degree to which this occurs will depend on the phase relationship and the relative amplitude of each. If the signals are in phase the interference will be constructive (that is, they add together to produce a stronger signal). If out of phase the interference will be destructive in which the signal will be reduced.

The phase relationship will depend on the difference in path length for the two signals. If the reflected signal travels further by half a wavelength, the two signals will be 180 degrees out of phase and will cancel each other.

We can calculate the path lengths using simple trigonometry:

$$P_d = \text{Direct path} = \sqrt{D^2 + (H_a - H_e)^2}$$

and

$$P_r = \text{Reflected path} = \sqrt{D^2 + (H_a + H_e)^2}$$

Where D = test distance,

$H_e$  = EUT height

and

$H_a$  = antenna height.

Path difference is  $P_r - P_d$ .

It's a relatively simple task to enter these equations into Excel and to try varying the factors.

For D = 3m, EUT height = 0.8m (as required by the standards) and antenna height = 1m

Then path difference is 0.492m, which is half wavelength for 304MHz

So if you have an emission at 304MHz, this will 'disappear' (actually it reduces by about 17dB, due to the fact that the reflected signal has travelled further and is therefore not as strong as the direct signal, so cancellation is not 100%).

This is clearly a problem. It accounts for the requirements in the standards which specify.....

- (a) a reflective (metal) ground plane should be used (which ensures repeatability between sites)
- (b) the antenna should be 'height scanned' to find the maximum level for each emission frequency. At this point, the two signals should be in-phase and the level will be some 5dB above free space (ie no reflected signal) level. The limits take this increase into account. This means that if using an FAC, the limits need to be reduced by 5dB to account for the lack of reflection.

An Excel utility is available at <http://www.laplace.co.uk/downloads/3/> Select 'RF Field Simulator'. Unzip and run RFMEAS.xls This shows graphically the effect of height scanning and also shows the effect of varying the test distance. EMCROOMS.doc provides an explanation of the .xls files.

There are 2 issues that are now apparent.

Even if we have a 'perfect' site, we still suffer gross errors if height scanning is not performed. This height scan requirement covers a range 1m to 4m. This 'error' relates to just one reflection. Imagine what may happen in a building where we are inevitably surrounded by the building structure, desks, filing cabinets, radiators, etc.... Even in a car park, we may have cars, metal fences and adjacent buildings.

Note that these issues apply regardless of the sophistication and accuracy of the instrumentation!

Obviously, accurate measurements of radiated emissions are an issue on typical 'pre-compliance' test sites.

### How the ERS helps.

Because the ERS generates a precisely known emission level at 3m, as measured on a perfect site (NPL), using the full rigour of the techniques as prescribed in CISPR16, we can use this to measure the 'errors' related to our test site.

For example, we have an emission from our product at 304MHz, and we measure it to be 38dBuV/m. This is well within the limits for EN55022, class B which are at 47dBuV/m for a 3m test distance. So our emissions are apparently 9dB below the limit.. If however, we substitute the product for the ERS, ensuring that the ERS is in exactly the same position as the product was, we can now measure the 304MHz output from the ERS. Assume its level is measured at 56dBuV/m. Checking the calibration data for the ERS, it shows that the 304MHz peak should be at 68dBuV/m. So on this test site, at this frequency, any RF signal source at the location of the EUT will measure 12dB low. So the EUT emission at 304MHz must also be measuring 12dB low, in which case the actual measurement should be  $38 + 12 = 50$ dBuV/m, which is over the limit.

This scenario is entirely typical. The use of an ERS clearly shows that in most typical non-compliant sites, errors in the range -16dB/+8dB are common, especially with indoor sites.

### How it can be used.

There are two strategies that can be used with an ERS.

- A. A manual technique as described above. This is generally more accurate and can avoid the significant problem that may arise if the EUT is large and/or has cables connected to it. It can be appreciated that it is important to match the location of the ERS with the location of the source of emissions from the EUT. It is therefore good practice to use a near field probe to locate the 'real' source. This may not be the EUT itself, but a cable that is connected to it. Cables make excellent transmitting antennas, so if the cable is just the wrong length ( $\frac{1}{4}$  wavelength) it will radiate strongly, even if the apparent signal 'leaking' from the EUT is quite small.
- B. The process can be automated if the appropriate facilities are available in the post processing software allied to the analyser. Prior to the measurement of the EUT, the ERS is placed at the EUT intended location. A scan over the full frequency range is acquired, first with the ERS switched off, then with it switched on. Ambient cancellation techniques may be used to cancel any significant ambient emissions. Because the ERS emissions are precisely located at 2MHz intervals, the scan could be arranged to step in 2MHz increments rather than perform a conventional sweep. Given that the RBW is 120KHz (CISPR16) this technique not only speeds up the scan, it ignores the unwanted 1880KHz between each ERS peak, thus dramatically improving apparent s/n ratio. Once the scans have been acquired, the software could compare the results with the pre-loaded calibration data for the ERS. The difference will be the 'site adjustment factor' which could be applied to the results received from the EUT. This could be entirely automated and applied as the scans are acquired. Note that this factor is only relevant to emissions whose source is located close to the location of the ERS. This means that the factor is not relevant to emissions from anywhere else (including ambients). So it is important to only apply the factor to the 'difference' trace (with the ambient subtracted). The Laplace system has all this functionality built-in thus providing a means for significantly improving measurement accuracy.

It is clear that current techniques for radiated emission testing is heavily dependent on the test site. The test site can (and will) introduce far greater errors than the instrumentation. The ERS provides a means for a complete end-to-end verification of the measurement. It includes not only the effect of the test site, but includes all other factors such as ...

- Lack of height scanning
- Antenna characteristics
- Cabling

- Pre-amp (if used)
- Analyser and software.

A fundamental requirement when using an ERS is that once it is used... test site must remain stable. Any change will invalidate the correlation. This means that the requirement for height scanning is nullified, and a fixed height must be maintained.

#### Limitations of the technique.

Even with the ERS, it is necessary to make the site as 'open' as practical. The more enclosed the space, the more critical source position becomes. In particular:

- never support the EUT on tables with any metal content.
- Locate the EUT away from metal surfaces.
- Ensure the EUT – antenna distance is at least 3m.
- Ensure that the test site is stable

#### A Real Example

A 3m test site was established in the car park. A mobile reflection device (Volvo XC70) was



used to check the effects of a typical reflection situation.

The EUT was a CMOS oscillator connected to a 0.8m wire, hung vertically (simulated mains cord).

No 'proper' ground plane was used.

Initial test was with the reflection device 'close'.

With the EUT switched off the ambient was first scanned using an averaging technique to reduce the effects of ambient instability. Once this result had been stored, the EUT was switched on and the

scanning repeated.

EUT emissions can be seen at 50, 70 and possibly, 90MHz. A peak at 110MHz also shows, but this is well down below the limit level.

The potential 90MHz peak is close to an existing FM frequency, so to check this, the scan is zoomed to see the relevant frequencies in more detail....

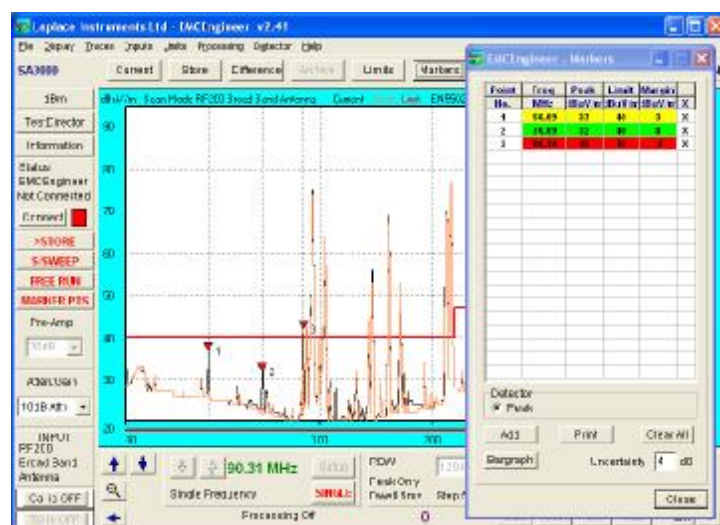

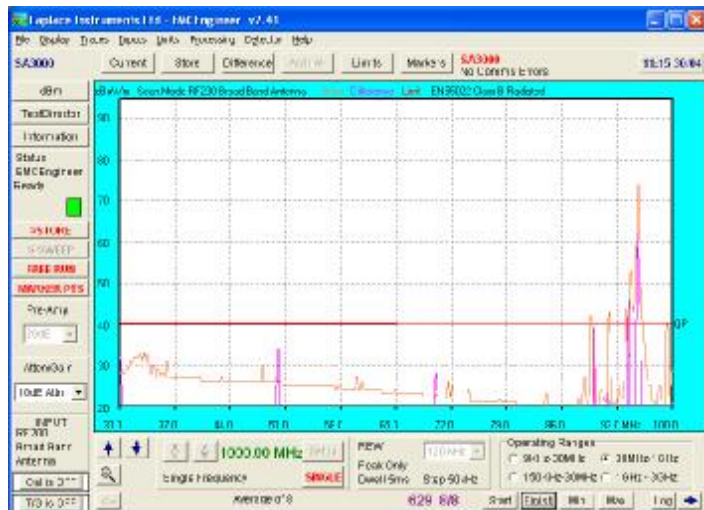

The difference trace is also invoked. This highlights the 50 and 70MHz peaks, and also shows a 90MHz emission plus some emissions in the 93 – 96MHz region. These latter are aligned with strong FM broadcast signals, and FM is by definition, a fluctuating signal.

To check that the 90MHz signal is in fact from the EUT, single frequency mode was used to monitor this frequency and the EUT switched off and on ....



Single frequency mode plots the level of one frequency against time, so as we can see, the horizontal timebase shows current time.

The results are obvious!  
Between approx. 11:15:00 and 11:32:00 (17 seconds) the source was switched off.

Next step was to replace the EUT with an ERS. There needs to be a judgement as to where the ERS should be located. At a maximum emission frequency of 90MHz, wavelength around 3.4m, quarter wavelength is 85cm. This correlates well with the wire extended from the EUT which was 80cm long. So it is obvious that the wire is the source of the emission. We therefore place the ERS at the 'centre of gravity' of the wire as shown in the next photograph.

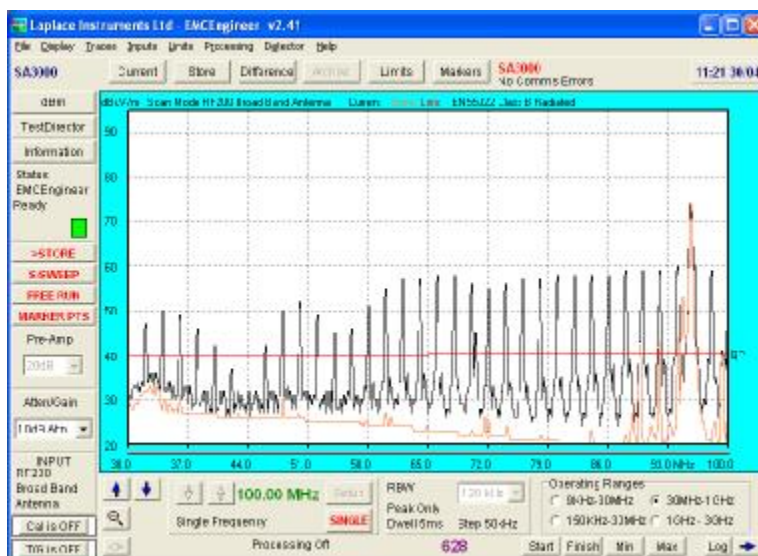

The frequency range of interest (30MHz – 100MHz) was scanned with the ERS switched on....

The 2MHz interval between peaks are clearly seen and measurement of the amplitude at the relevant frequencies is a simple task.



We then repeated the whole measurement process with the 'reflection device' removed to a remote location.

The 3 peaks are again observed and can be measured.

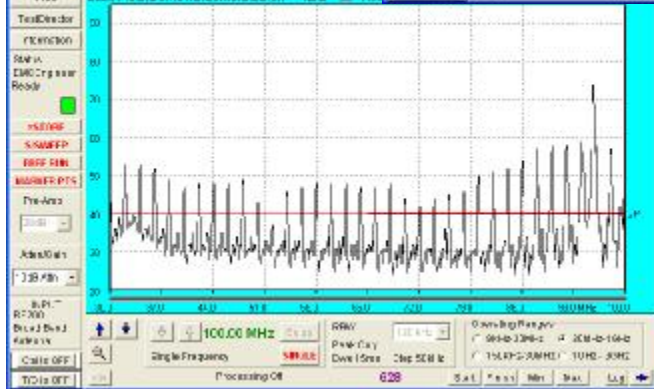
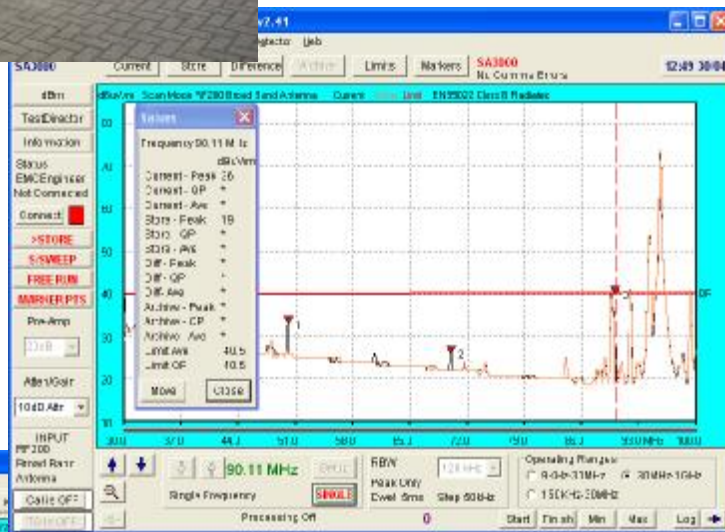

The measurement with the ERS was also repeated....

And finally the results were tabulated....

Frequency (MHz)	Calibration Data for ERS dBuV/m	Test 1 With reflection (dBuV/m)			Test 2 No reflection (dBuV/m)		
		EUT	ERS	Corrected	EUT	ERS	Corrected
50	53	35	52	36	28	44	37
70	57	29	56	30	18	44	31
90	59	39	59	39	36	58	37

The above results show that the ERS has been entirely effective in correcting the effects of the test site. The column labelled 'EUT' shows the wide variation between tests, but after the ERS correction has been applied, the results are all within 2dB.

### Conclusion

This rather 'ad hoc' test does show:

- the significant effect that the 'reflecting device' has on the results.
- And that the ERS is capable of 'normalising' results even under adverse conditions.
- Accuracy is significantly improved and measurements becomes repeatable.
- And (incidentally) it all shows how the length of the wire affected the dominant emission frequency. Its no coincidence that at 90MHz the quarter wavelength is close to 80cm wire length.

Independent testing of the EUT had already shown that it was very close to the limit at 90MHz, and that is indeed what the above tests have shown.

The ERS represents a relatively small investment, but its effect on the level of confidence that can be attributed to any measurements is dramatic. Note that although the ERS is designed to counter the effects due to the test site, it also confirms and checks the operation and calibration of the whole measurement system including test site, antenna, cables, pre-amplifiers and analyser/receiver.

A key message is that all the above applies, regardless of the sophistication and 'quality' of the instrumentation.

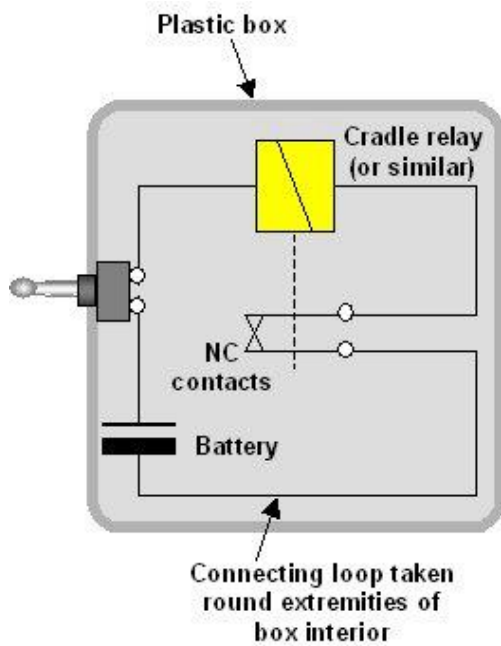
**Annex 10 The chattering relay**

This is a dc relay connected via its own NC contacts such that it is repeatedly opens and closes the contacts. This, in conjunction with the inductance of the relay coil, creates highly impulsive noise which is 'broadcast' by the looped connecting wire to the battery.

To see the effect, place a near field probe close to the box to see a wonderful broadband spectrum of noise!

## Annex 11 ESD test setup.

The setup needs to be done rigorously as the discharges feature high frequency components, so the arrangement needs to be compatible with RF techniques.

Discharges must be applied with both polarities.

Discharges using both contact (pointed tip) at 8kV and air discharge (rounded tip) at 15kV are specified. Contact is preferred, in which case the tip is rested on the surface first and then the discharge initiated.

Discharges are applied to any exposed metal including panels, screwheads, flanges, exposed connector contacts (except those with a metallic housing, in which case the discharge is applied to the housing only).

In the event that no suitable metal points are available, use air discharge around joints in plastic covers, connector covers and keypad.

In the event that there are no contact points, apply the discharges to the horizontal and vertical coupling planes by contact.

Products that are not grounded must be discharged to ground between each applied impulse using a discharge wire as indicated below.

Setup for mains powered equipment

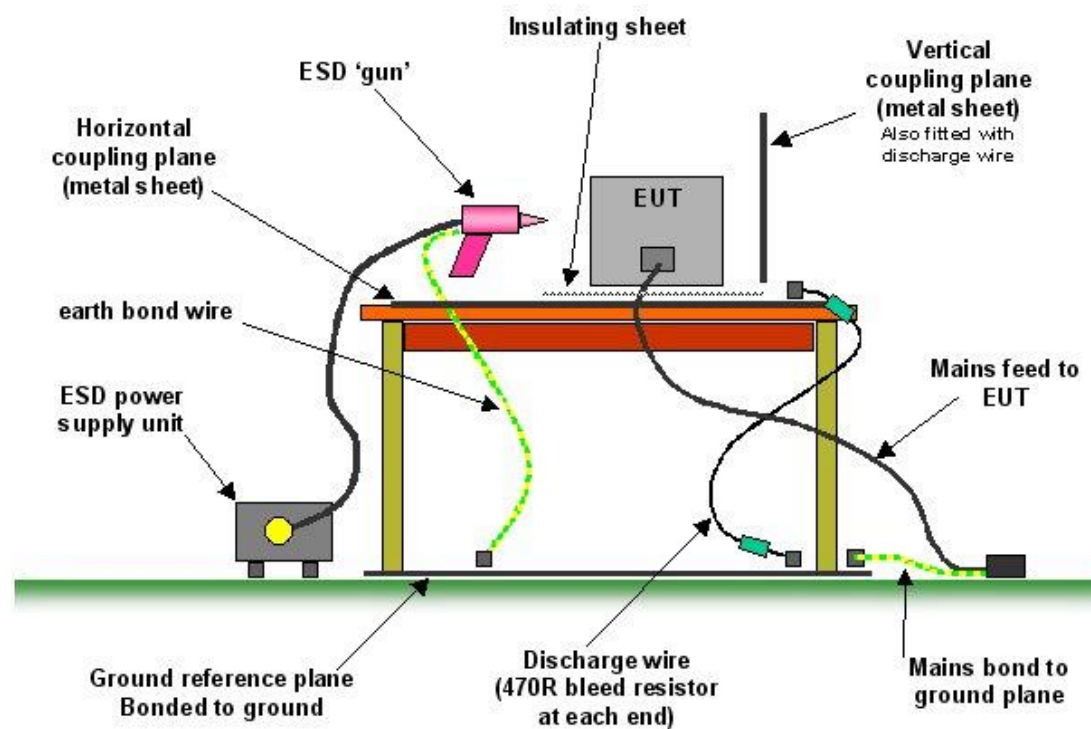

## Annex 12 Conducted RF testing

### IEC61000-4-6

Any product with one or more 'Ports' (attached cables) should be tested to this standard. It injects RF into each port, one at a time. Other ports must be fed through matching devices to maintain a 150R impedance 'environment' for the duration of the test.. If a product has 5 ports (eg, mains power (3 lines), USB interface, a co-ax input, a screened control cable (9 way Dee type), and an unscreened audio output cable (2 core)) then all 5 cables must be impedance matched, even though only one is being used for RF injection at any one time. The preferred type of device used for injection and impedance matching are CDNs. (Coupling Decoupling Networks), although EM Clamps or Bulk Current Injection probes (in conjunction with ferrite clamps) could be used.

CDNs are produced in 5 different varieties:

Type MMains and other power feeds, unscreened

Type ST Screened telecom cables

Type T Unscreened telecom cables

Type S Screened cables

Type AF Unscreened cables

Each variety is specified with the number of cable cores required...

So for a 2 wire mains cable (L, N), an M2 is required.

For a 3 wire mains cable (L, N, E), and M3 is required.

Because the whole product must be held in the 150ohm environment, any separate earth connection must also be impedance matched, in which case an M1 is used.

For the above example, the required CDNs are:

M3, ST4, S1, S9, AF2.

Normally, CDNs are individually matched to the number of cores in the cable, so for example, an ST8 cannot be used with a 4 core cable and an M3 cannot be used with an M2 cable. However the Laplace Versatile range of CDNs do enable a single CDN to cover cables with many different core variations. So an ST8 will cover an ST4 and ST2 also, and an M3 will cover an M2 and an M1.

Other equipment required:

- Signal generator (150KHz – 230MHz, with 1KHz AM modulation)
- Power amplifier, 150KHz – 230MHz, min 20W continuous output.
- RF Millivoltmeter.
- 6dB, 50R, 25W attenuator
- 150/50R calibration adaptor
- Control system and software.

The standard specifies a substitution technique for calibrating the input stress level.

Therefore there are 2 phases to each test...

With the equipment setup on a good ground plane, with the CDNs well grounded and the EUT mounted 10cm above the plane on insulating spacers, the output from the 'active' CDN is fed back to an RF millivoltmeter via a 150R/50R calibration adaptor, which is itself well grounded. Normally, the RF millivoltmeter is included with the main test unit.

Note that a 6dB attenuator is included in the power feed from the power amplifier. This ensures that any variation in the output impedance of the power amplifier is decoupled from the operation of the CDN, and presets a consistent load impedance to the amplifier.

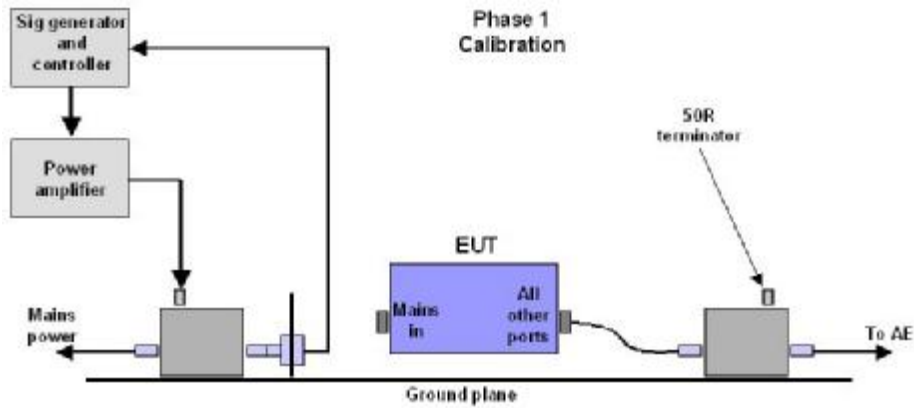

A sweep is run, and the signal generator output level controlled so the desired stress level appears at the RF millivoltmeter. The settings necessary to achieve this are logged. On completion of this initial calibration scan, the EUT is connected as shown in phase 2 below and the sweep run again using the same settings.

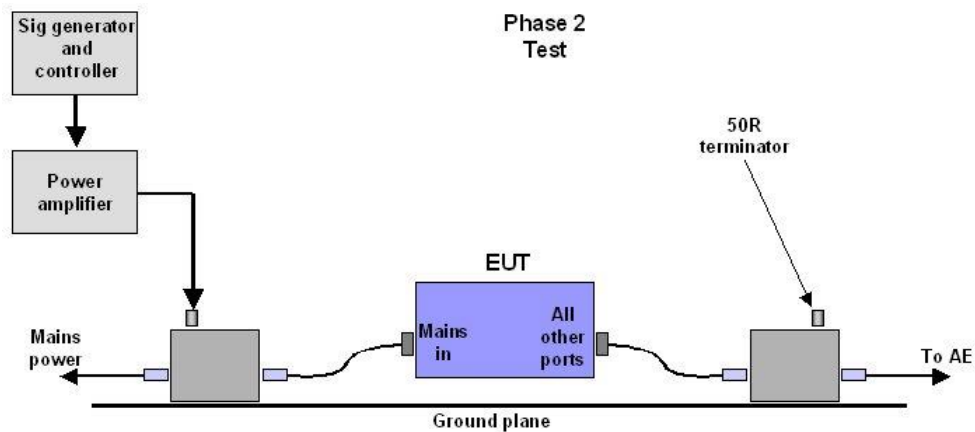

An alternative technique is to monitor the applied stress level as the EUT is being tested, thus controlling the level as the EUT is being tested. This accomplishes the test with only one phase, and eliminates the need for the 6dB attenuator, halving the output power requirements of the amplifier. To facilitate this technique, the Laplace 'Enhanced' CDNs are fitted with an additional monitor output port to provide the required feedback signal.

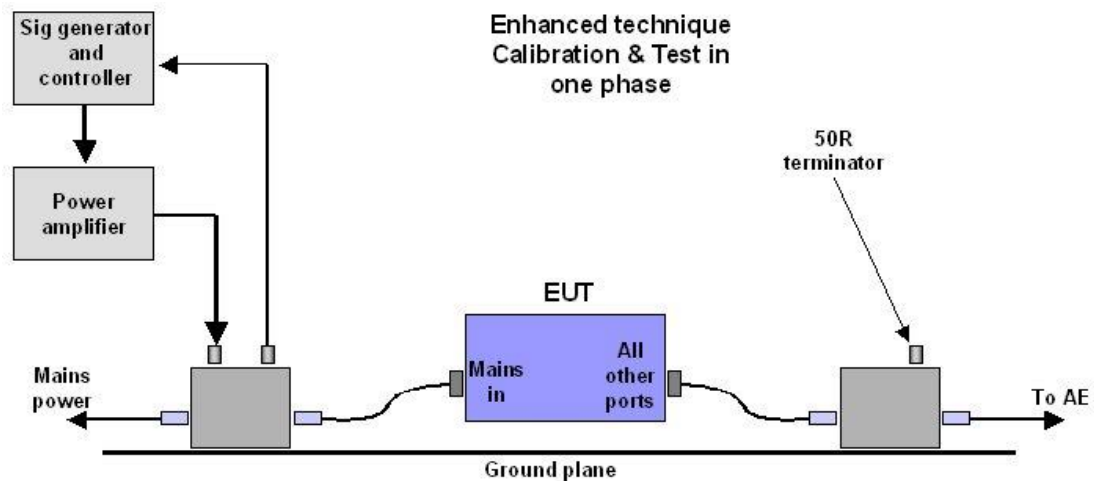

**Annex: 13 Ambient signals Frequency allocations**

This is a brief list of the major allocations. There is a vast amount of detail that is omitted. For more information enter 'UK frequency allocations' in Google.

Start frequency (MHz)	End frequency (MHz)	Service
24	---	USB bus clock (watch harmonics!)
50	51	Amateur
68	69	Amateur
87	108	FM broadcast
118	138	Air traffic control
127	---	R/C control
156	218	Ground mobile and marine
174	---	Radio microphones
218	230	DAB radio
394	---	TETRA (emergency services)
470	850	Terrestrial TV stations
863	865	Wireless microphones
880	960	Mobile phone band (GSM)
960	1215	Aeronautical navigation
1880	---	DECT cordless phones
1880	1980	Mobile phone band (UMTS)
2400	---	Bluetooth

**LAPLACE INSTRUMENTS LTD**

3B, Middlebrook Way  
Cromer  
Norfolk NR27 9JR  
UK

Tel: 012 63 51 51 60

Fax: 012 63 51 25 32

E: [tech@laplace.co.uk](mailto:tech@laplace.co.uk)

Web: [www.laplaceinstruments.com](http://www.laplaceinstruments.com)

